



## DESCRIPTION

---

CGAxis Models Volume 31 - MUSIC STUDIO collection containing 30 highly detailed 3D models of music studio equipment and instruments. You can find in it : guitars, pianos, keyboards, audio racks, headphones, speakers and many more. Great for your interior visualization projects. Models are mapped and have materials and textures. Compatible with 3ds max 2008 or higher and many others.

## SPECIFICATION

---

Total size: 2.25 GB

Materials: YES

Textures: YES

## FORMATS

---

\*.max (Scanline)

\*.max (MentalRay)

\*.max (VRay)

\*.c4d

\*.c4d (VRay)

\*.obj

\*.fbx

All models, textures, renders, materials, hdri etc. which can be purchased/downloaded from [www.cgaxis.com](http://www.cgaxis.com) are on Royalty-Free non-exclusive license. License is personal and NON transferable. Models, textures, renders, materials, hdri etc. that You have purchased are non-exclusively licensed, NOT sold to You. You can use CGAxis products as a part of a game, if the products are contained inside a proprietary format and displays inside the game during play. In this case, you have to add in the producer's section the information that "models by CGAXIS.com". You can sell/resell rendered moving or still images, resold as a part of a feature film, movie advertisement etc. You have a possibility to publish renders in a book, on a poster, t-shirt, magazine, cover or any other item. You have the right to use your renders in every way - charge a fee for them, modify them, to make postproduction etc.

## ACOUSTIC GUITAR

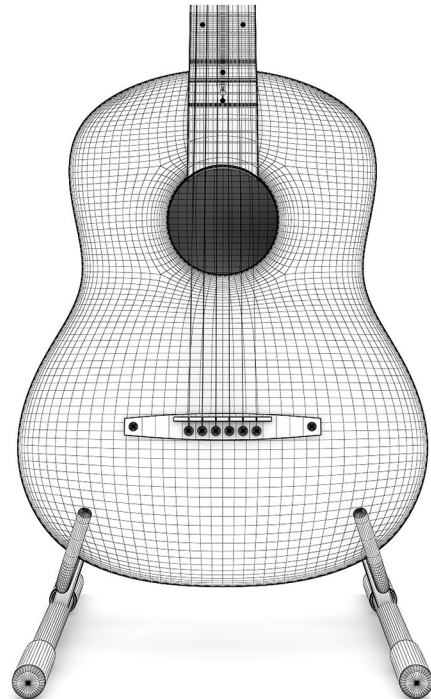

FILENAME: CGAXIS\_MODELS\_31\_01

## ELECTRIC GUITAR



FILENAME: CGAXIS\_MODELS\_31\_02

## VIOLIN



FILENAME: CGAXIS\_MODELS\_31\_03

## GRAND PIANO

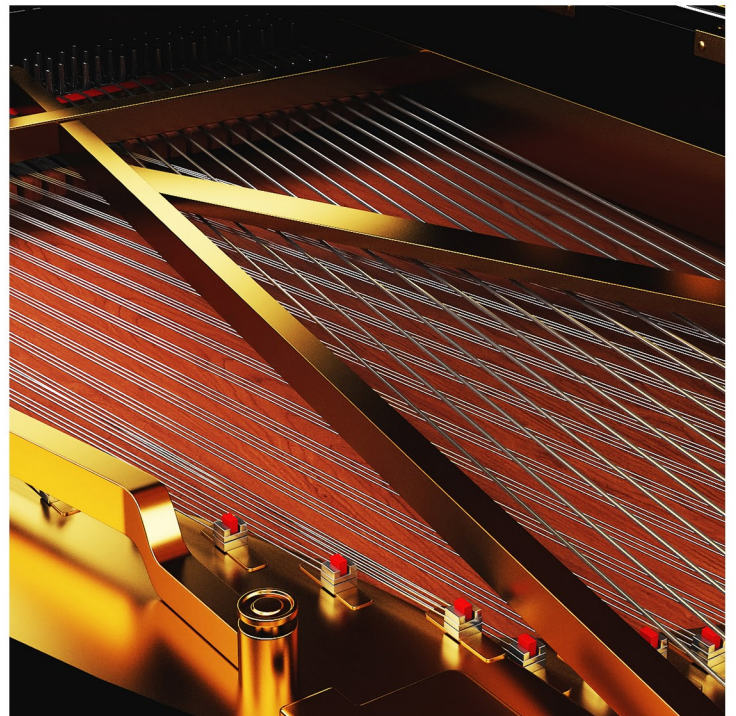
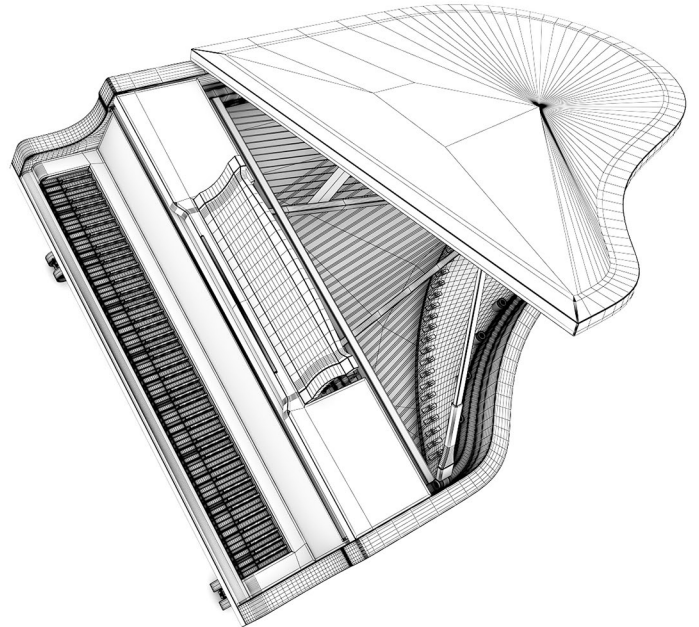

FILENAME: CGAXIS\_MODELS\_31\_04

## UPRIGHT PIANO

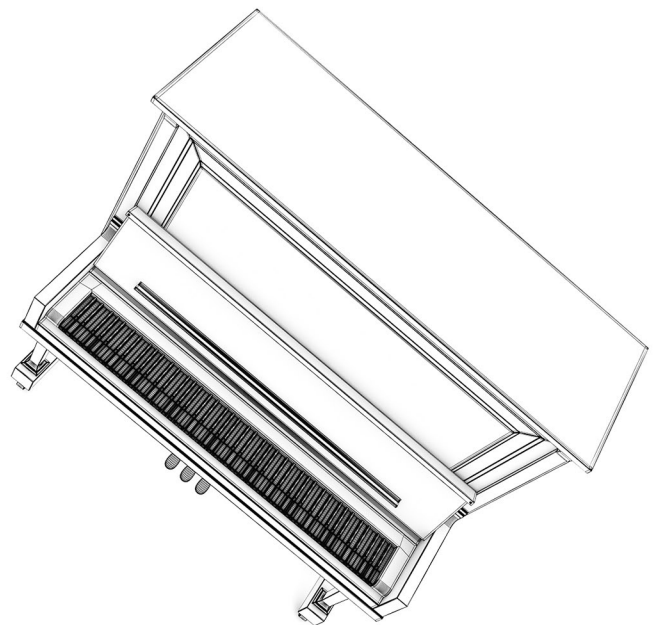

FILENAME: CGAXIS\_MODELS\_31\_05

## KEYBOARD WORKSTATION 1



FILENAME: CGAXIS\_MODELS\_31\_06

## KEYBOARD WORKSTATION 2

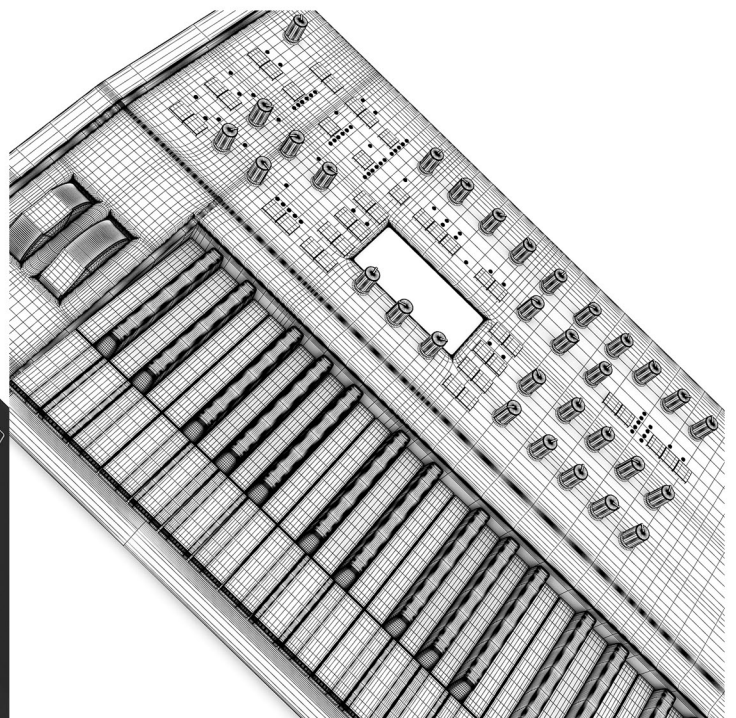
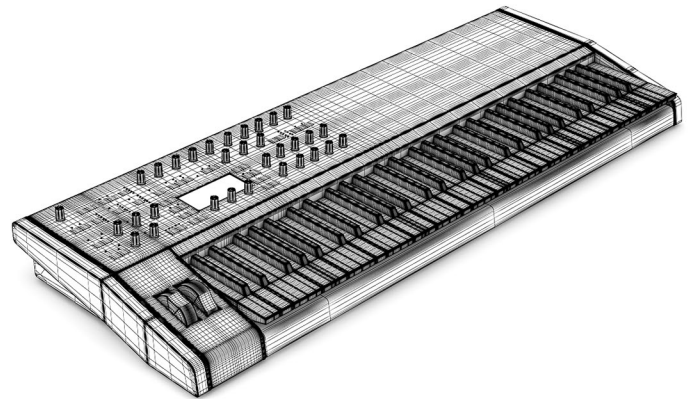

FILENAME: CGAXIS \_ MODELS \_ 31 \_ 07



## KEYBOARD SYNTHESIZER

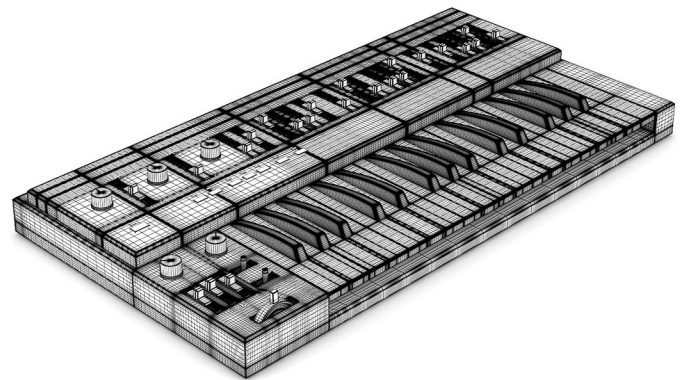

FILENAME: CGAXIS\_MODELS\_31\_08

## KEYBOARD WORKSTATION 3

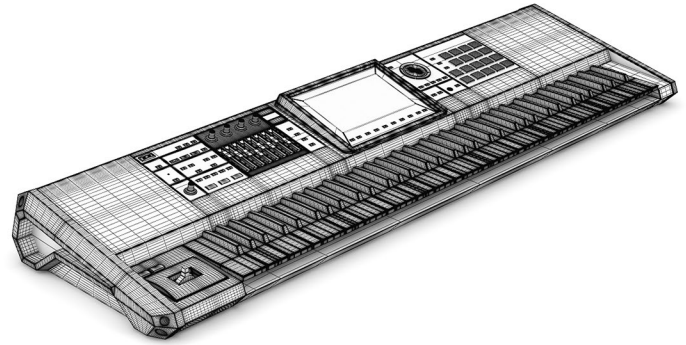

FILENAME: CGAXIS\_MODELS\_31\_09

## TURNTABLE

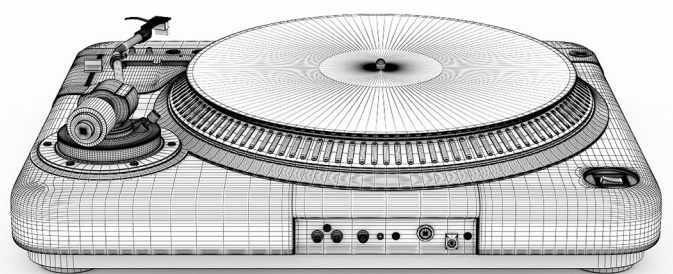

FILENAME: CGAXIS \_ MODELS \_ 31 \_ 10

## DJ's CONTROLLER

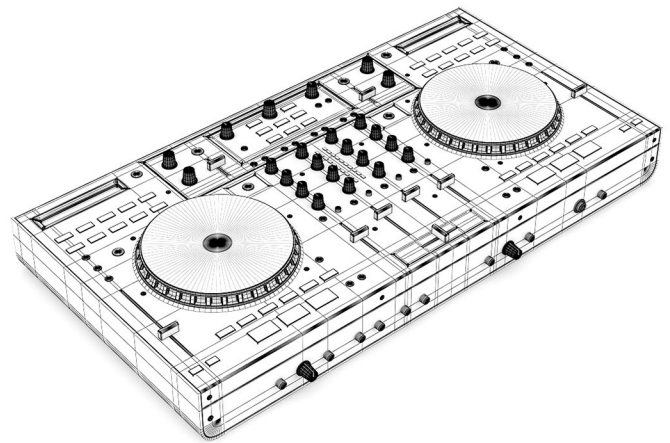

FILENAME: CGAXIS\_MODELS\_31\_11

## HEADPHONES 1

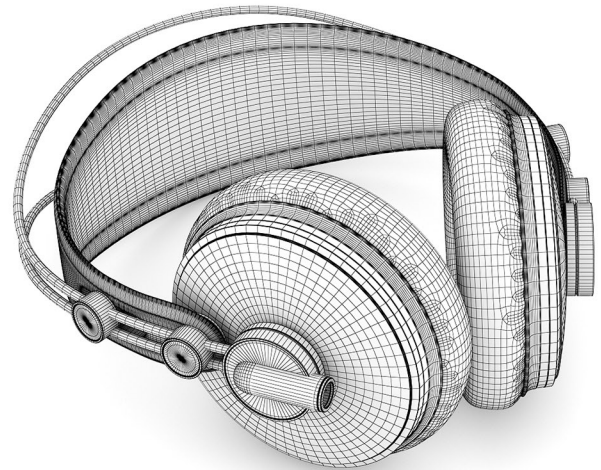

FILENAME: CGAXIS\_MODELS\_31\_12

## HEADPHONES 2

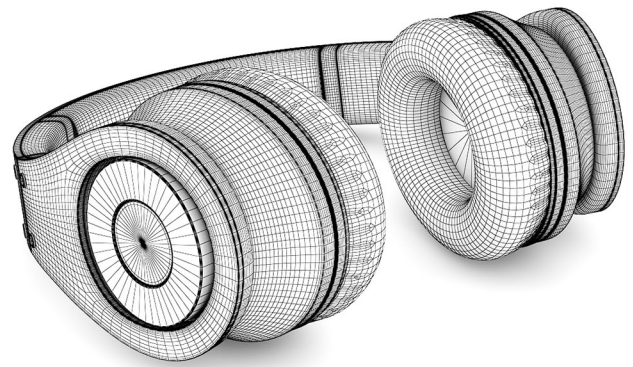

FILENAME: CGAXIS \_ MODELS \_ 31 \_ 13

## MICROPHONE 1

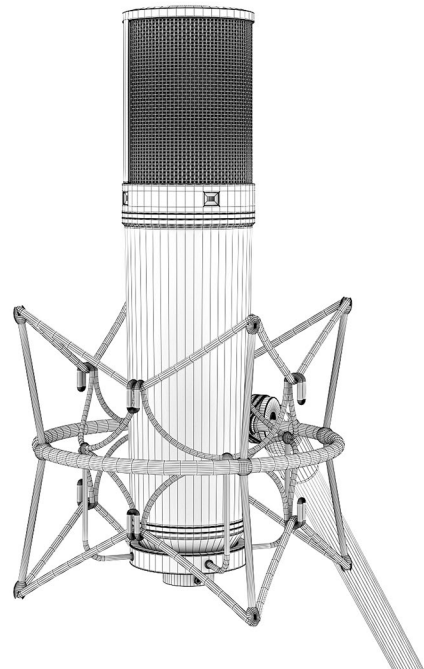

FILENAME: CGAXIS \_ MODELS \_ 31 \_ 14

## MICROPHONE 2



FILENAME: CGAXIS\_MODELS\_31\_15



## STUDIO MONITORS

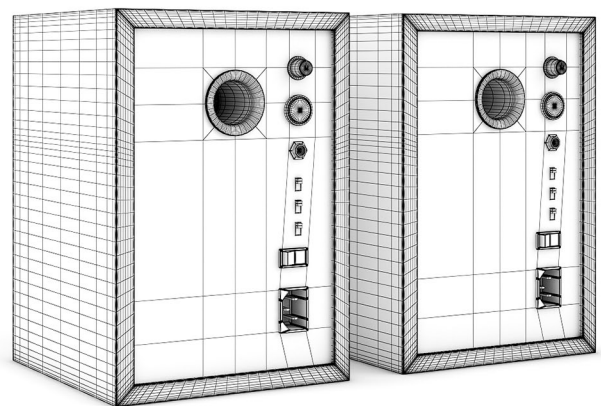
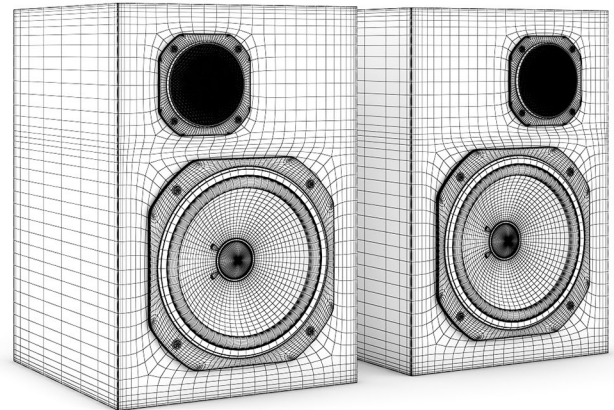

FILENAME: CGAXIS\_MODELS\_31\_16

## STUDIO MONITOR



FILENAME: CGAXIS\_MODELS\_31\_17

## STUDIO MIXER

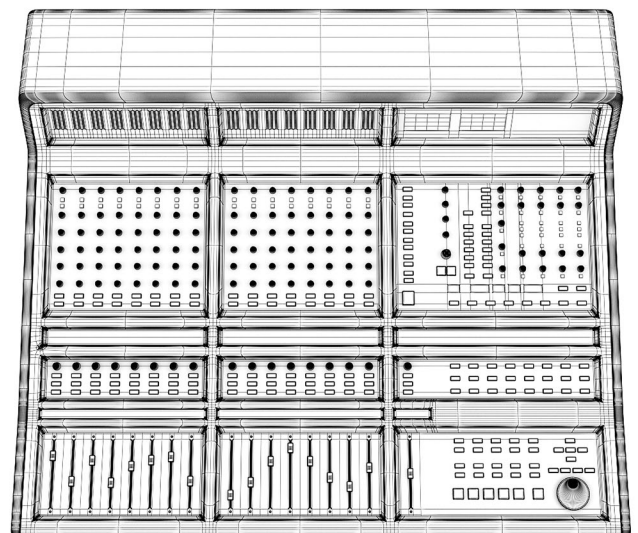
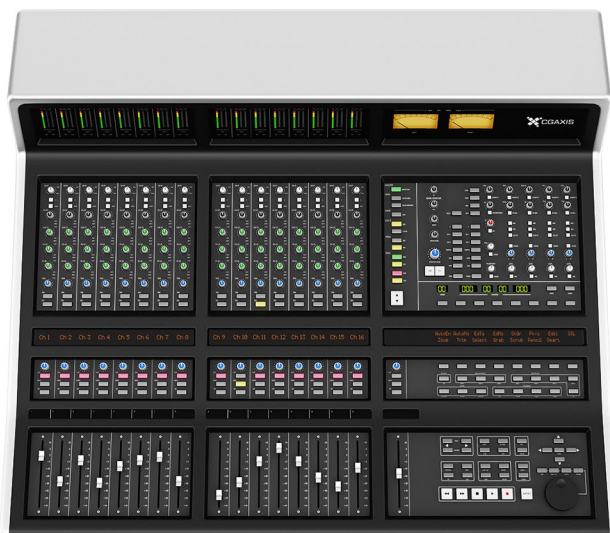
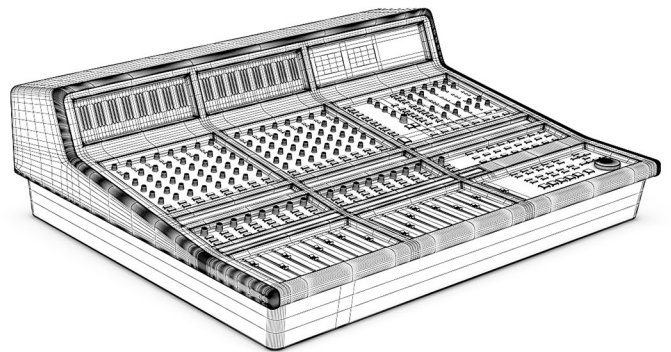

FILENAME: CGAXIS\_MODELS\_31\_18

## PAD CONTROLLER 1

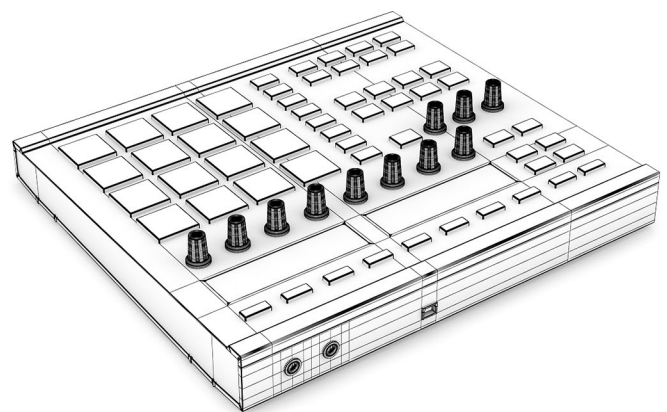
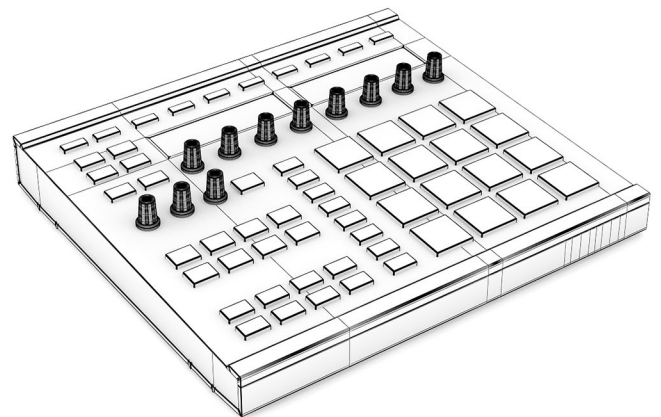

FILENAME: CGAXIS \_ MODELS \_ 31 \_ 19

PAD CONTROLLER 2

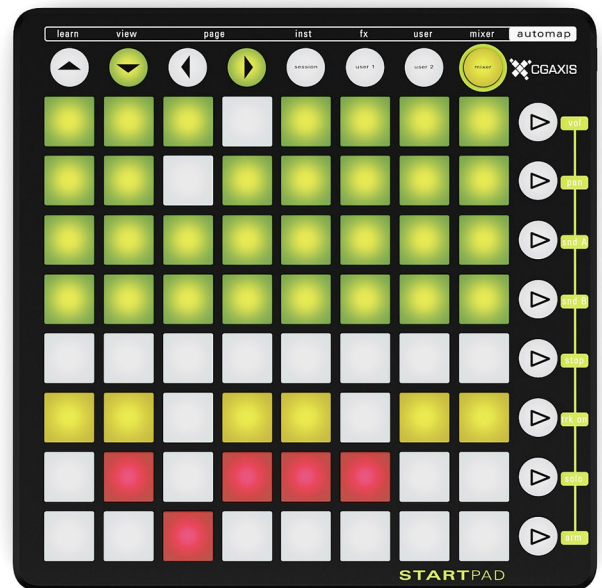
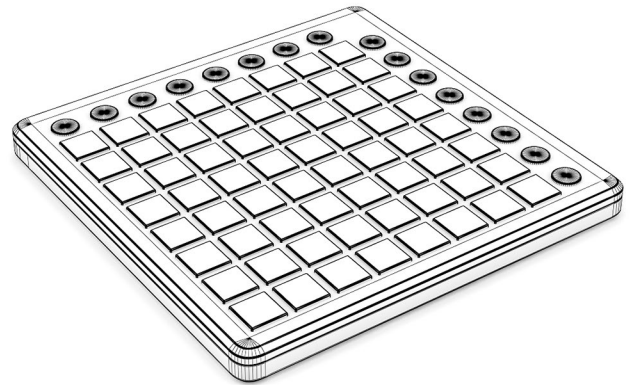

FILENAME: CGAXIS \_ MODELS \_ 31 \_ 20

## AUDIO RACK 1

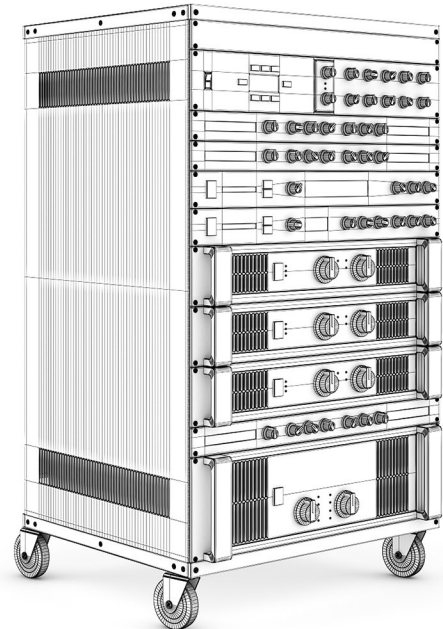

FILENAME: CGAXIS\_MODELS\_31\_21

## AUDIO RACK 2

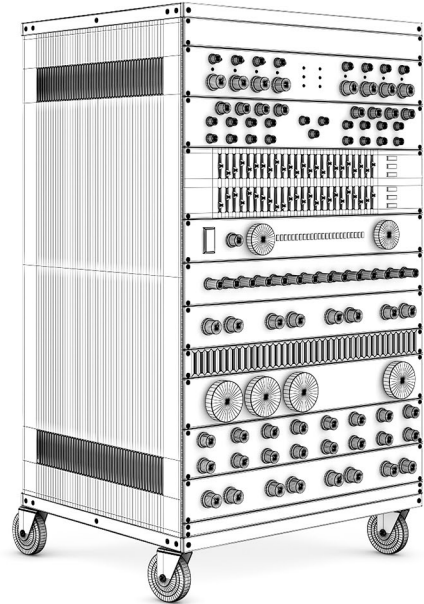

FILENAME: CGAXIS\_MODELS\_31\_22

## STUDIO DESK 1

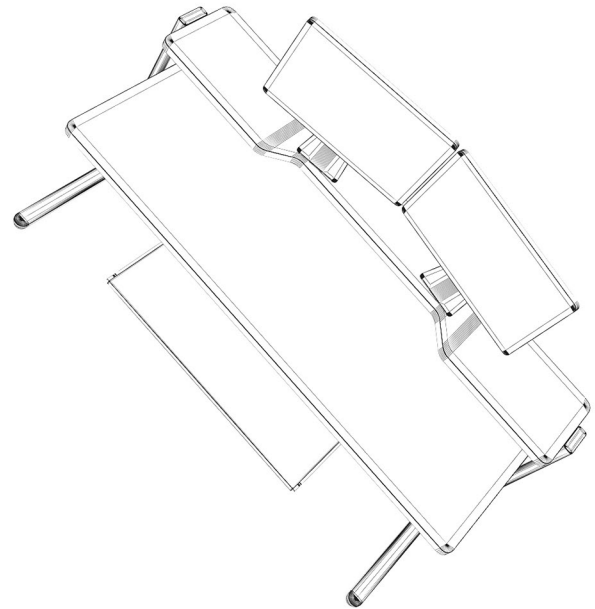
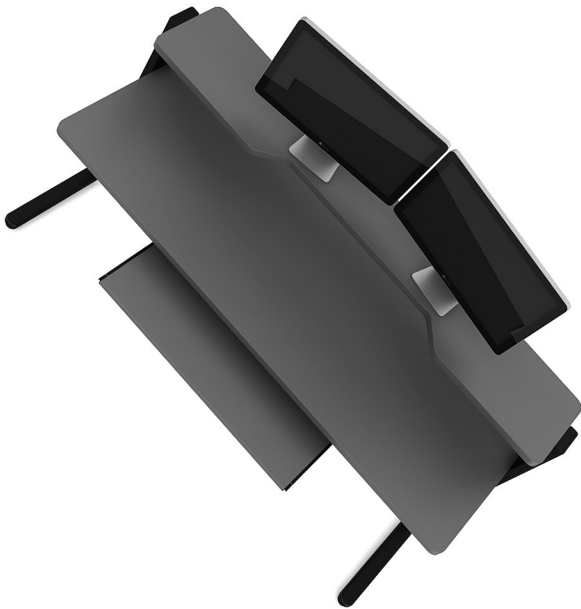
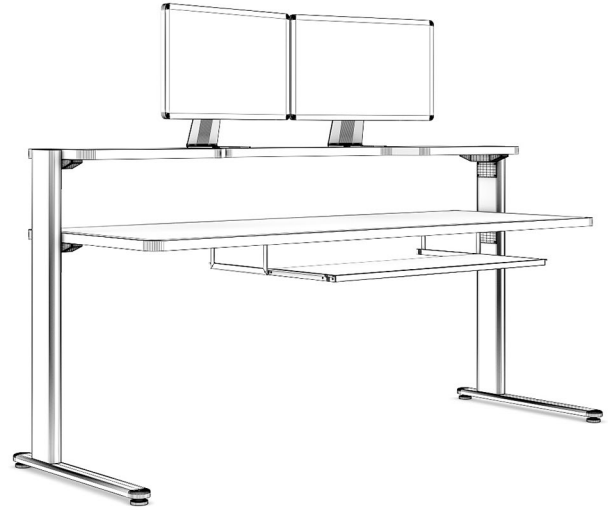

FILENAME: CGAXIS\_MODELS\_31\_23



## STUDIO DESK 2

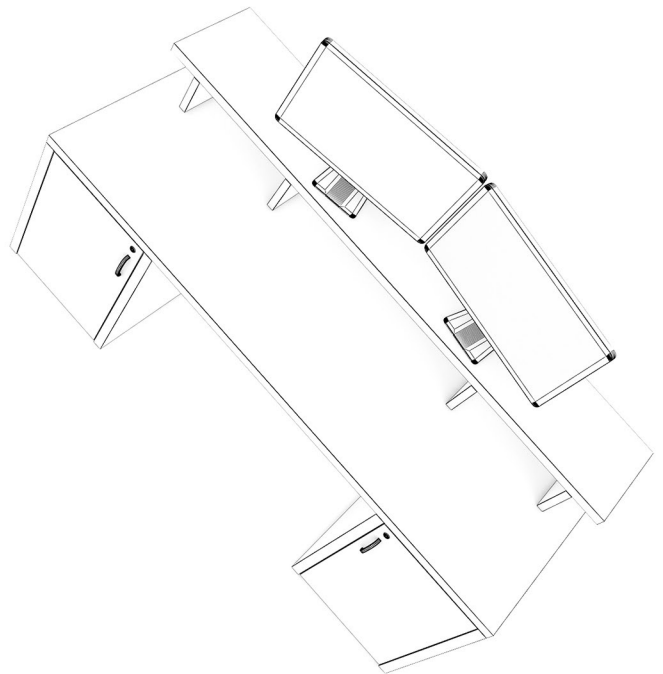

**FILENAME: CGAXIS \_ MODELS \_ 31 \_ 24**

## KEYBOARD STAND 1

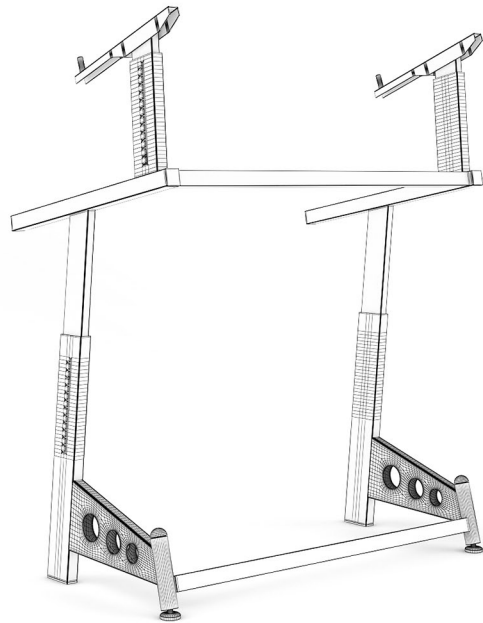
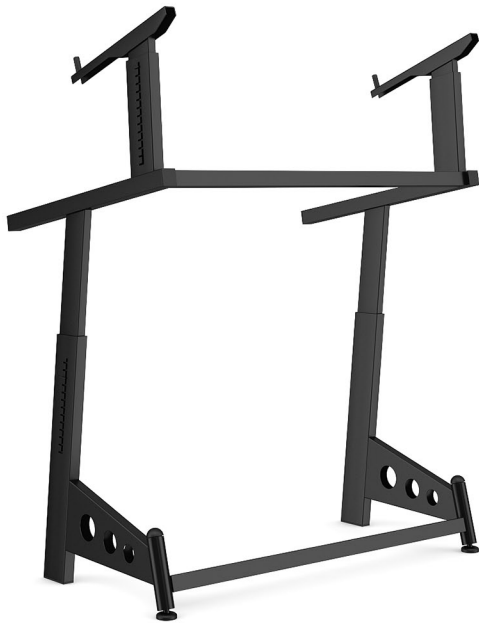
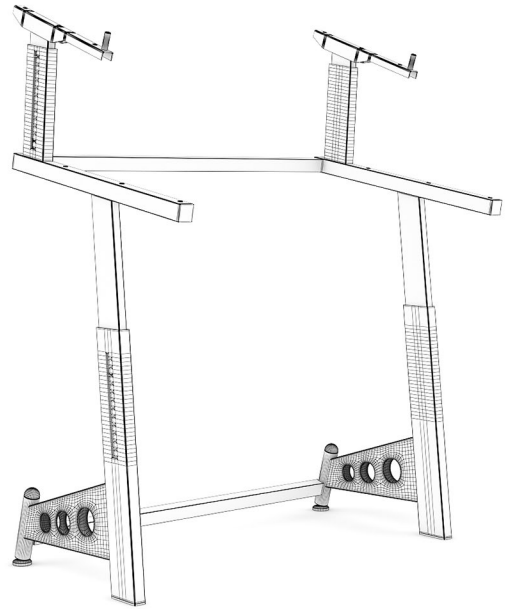

FILENAME: CGAXIS\_MODELS\_31\_25

## KEYBOARD STAND 2



FILENAME: CGAXIS\_MODELS\_31\_26

## ACOUSTIC PANEL 1

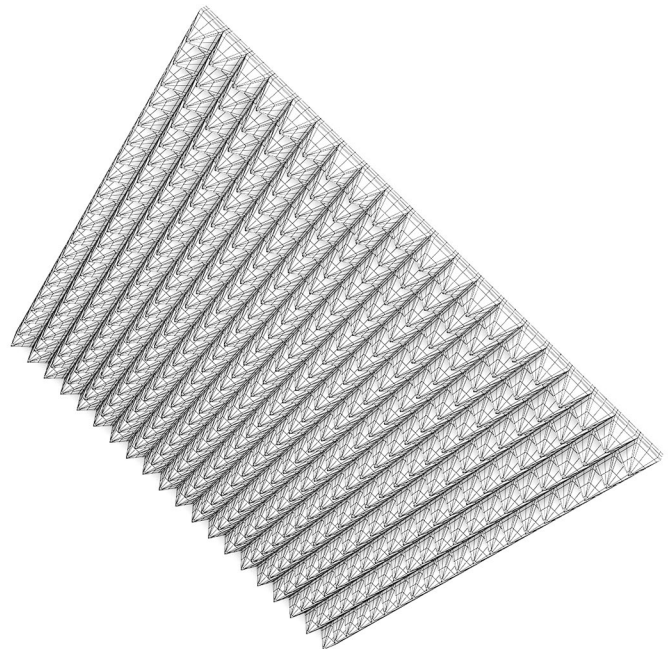
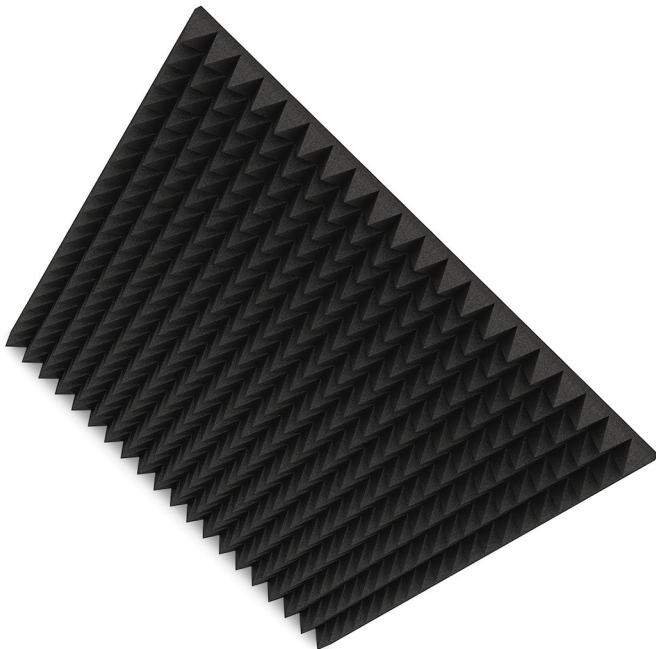
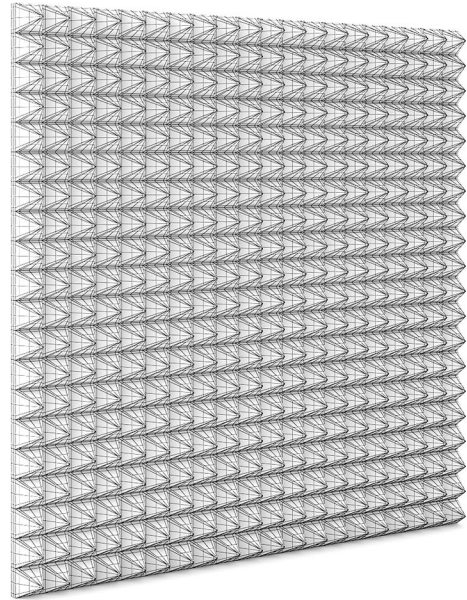
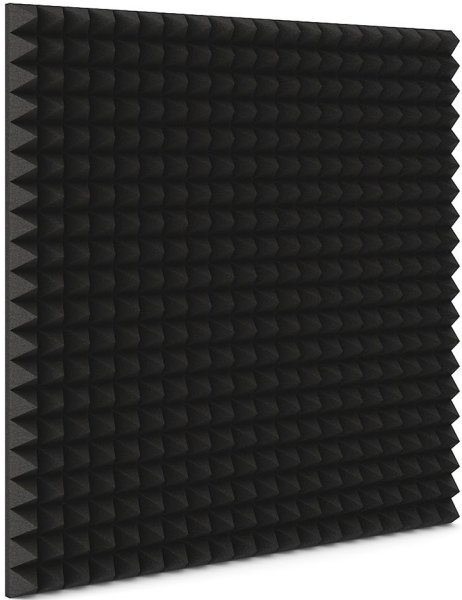

FILENAME: CGAXIS \_ MODELS \_ 31 \_ 27

## ACOUSTIC PANEL 2

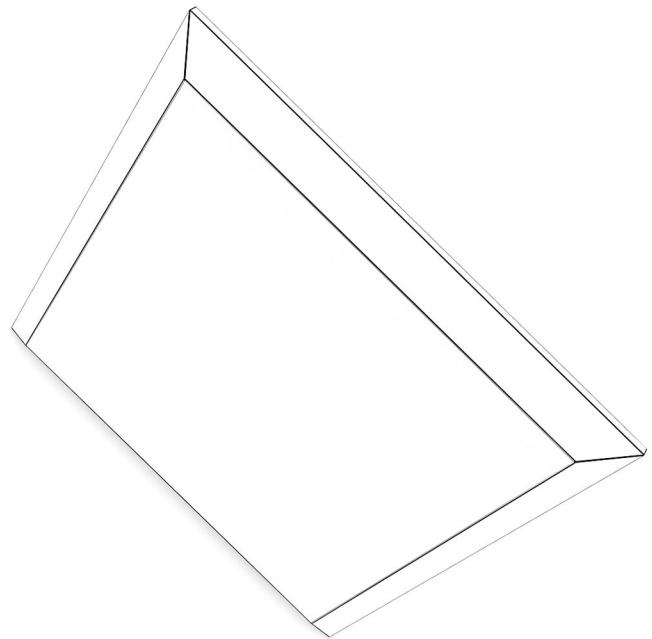
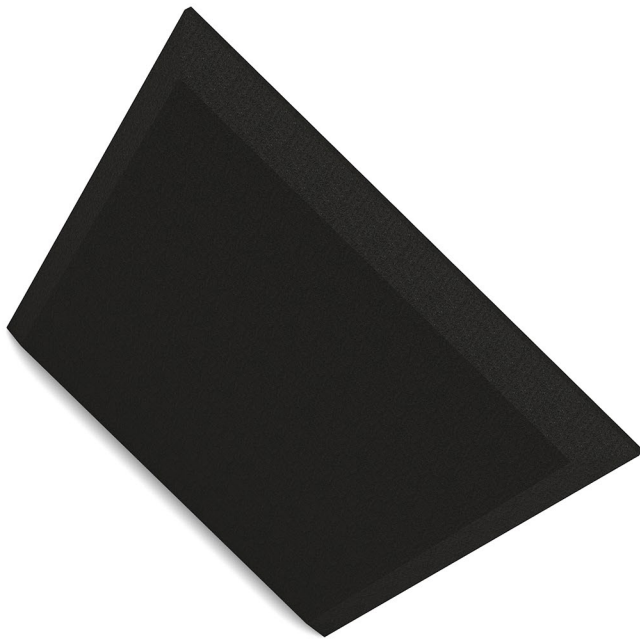
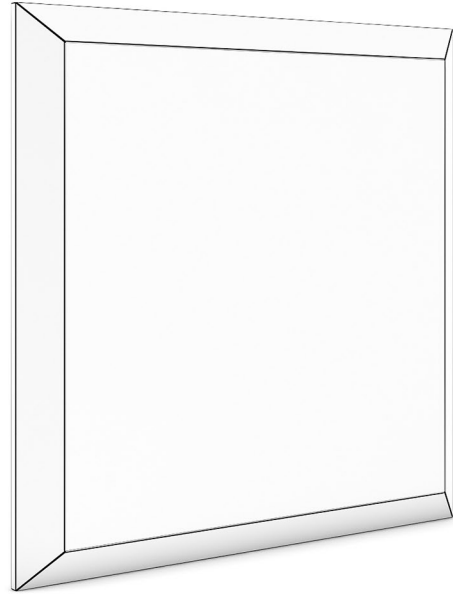
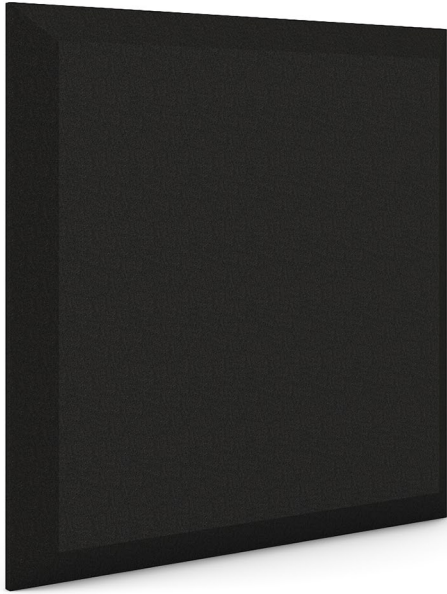

FILENAME: CGAXIS \_ MODELS \_ 31 \_ 28

## CORNER BASS TRAP 1

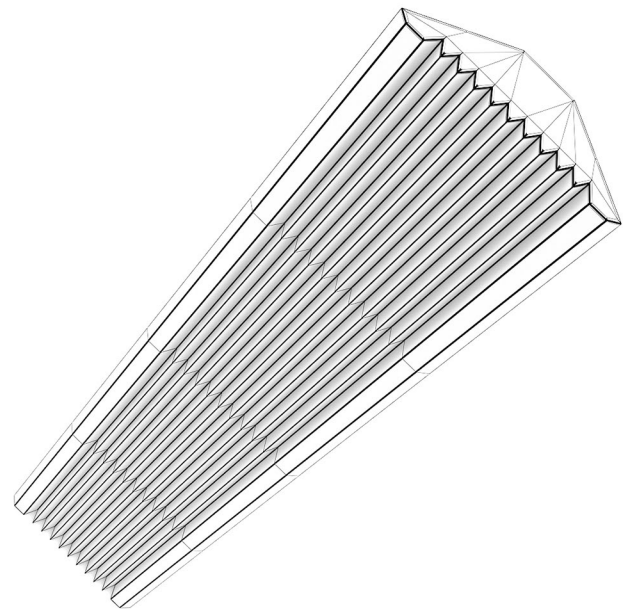
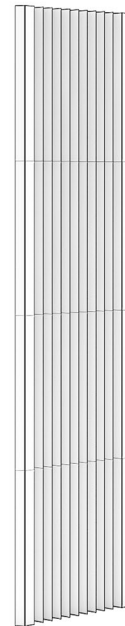

FILENAME: CGAXIS \_ MODELS \_ 31 \_ 29

## CORNER BASS TRAP 2

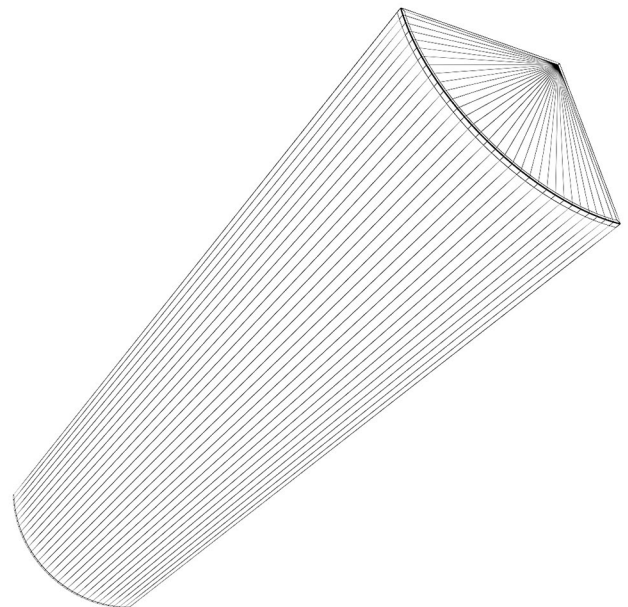
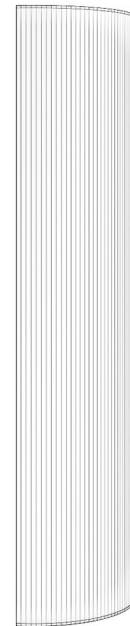

FILENAME: CGAXIS \_ MODELS \_ 31 \_ 30