

# BATHROOMS

## collection

VOLUME 22

001

### NAME

CGAxis Models Volume 22:  
Bathrooms Collection

### FORMATS

- \*.max (Scanline)
- \*.max (MentalRay)
- \*.max (VRay)
- \*.c4d
- \*.c4d (VRay)
- \*.fbx
- \*.obj

### SPECIFICATION

Total size: 1.68 GB  
Materials: YES  
Textures: YES

### DESCRIPTION

CGAxis Models Volume 22 containing 70 highly detailed models of bathrooms appliances. Great for your project, compatible with 3ds max 2008 or higher and many others.



All models, textures, renders, materials, hdri etc. which can be purchased/downloaded from [www.cgaxis.com](http://www.cgaxis.com) are on Royalty-Free non-exclusive license. License is personal and NON transferable. Models, textures, renders, materials, hdri etc. that You have purchased are non-exclusively licensed, NOT sold to You. You can use CGAxis products as a part of a game, if the products are contained inside a propriety format and displays inside the game during play. In this case, you have to add in the producer's section the information that "models by CGAXIS.com". You can sell/resell rendered moving or still images, resold as a part of a feature film, movie advertisement etc. You have a possibility to publish renders in a book, on a poster, t-shirt, magazine, cover or any other item. You have the right to use your renders in every way - charge a fee for them, modify them, to make postproduction etc.

# BATHROOMS

## collection

VOLUME 22

002

### NAME

CGAxis Models Volume 22:  
Bathrooms Collection

### FORMATS

- \*.max (Scanline)
- \*.max (MentalRay)
- \*.max (VRay)
- \*.c4d
- \*.c4d (VRay)
- \*.fbx
- \*.obj

### SPECIFICATION

Total size: 1.68 GB  
Materials: YES  
Textures: YES

### DESCRIPTION

CGAxis Models Volume 22 containing 70 highly detailed models of bathrooms appliances. Great for your project, compatible with 3ds max 2008 or higher and many others.



All models, textures, renders, materials, hdri etc. which can be purchased/downloaded from [www.cgaxis.com](http://www.cgaxis.com) are on Royalty-Free non-exclusive license. License is personal and NON transferable. Models, textures, renders, materials, hdri etc. that You have purchased are non-exclusively licensed, NOT sold to You. You can use CGAxis products as a part of a game, if the products are contained inside a propriety format and displays inside the game during play. In this case, you have to add in the producer's section the information that "models by CGAXIS.com". You can sell/resell rendered moving or still images, resold as a part of a feature film, movie advertisement etc. You have a possibility to publish renders in a book, on a poster, t-shirt, magazine, cover or any other item. You have the right to use your renders in every way - charge a fee for them, modify them, to make postproduction etc.

# BATHROOMS

## collection

VOLUME 22

003

### NAME

CGAxis Models Volume 22:  
Bathrooms Collection

### FORMATS

- \*.max (Scanline)
- \*.max (MentalRay)
- \*.max (VRay)
- \*.c4d
- \*.c4d (VRay)
- \*.fbx
- \*.obj

### SPECIFICATION

Total size: 1.68 GB  
Materials: YES  
Textures: YES

### DESCRIPTION

CGAxis Models Volume 22 containing 70 highly detailed models of bathrooms appliances. Great for your project, compatible with 3ds max 2008 or higher and many others.

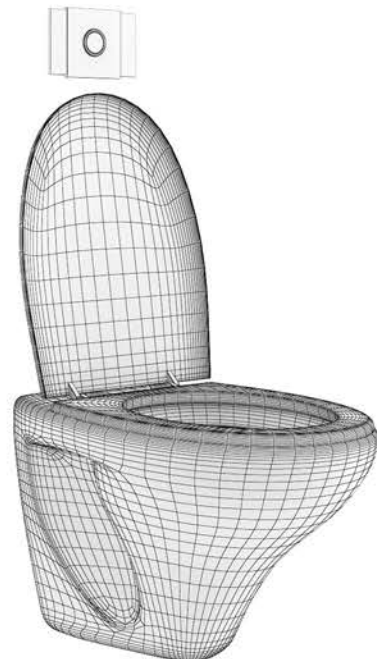

All models, textures, renders, materials, hdri etc. which can be purchased/downloaded from [www.cgaxis.com](http://www.cgaxis.com) are on Royalty-Free non-exclusive license. License is personal and NON transferable. Models, textures, renders, materials, hdri etc. that You have purchased are non-exclusively licensed, NOT sold to You. You can use CGAxis products as a part of a game, if the products are contained inside a propriety format and displays inside the game during play. In this case, you have to add in the producer's section the information that "models by CGAXIS.com". You can sell/resell rendered moving or still images, resold as a part of a feature film, movie advertisement etc. You have a possibility to publish renders in a book, on a poster, t-shirt, magazine, cover or any other item. You have the right to use your renders in every way - charge a fee for them, modify them, to make postproduction etc.

# BATHROOMS

## collection

VOLUME 22

004

### NAME

CGAxis Models Volume 22:  
Bathrooms Collection

### FORMATS

- \*.max (Scanline)
- \*.max (MentalRay)
- \*.max (VRay)
- \*.c4d
- \*.c4d (VRay)
- \*.fbx
- \*.obj

### SPECIFICATION

Total size: 1.68 GB  
Materials: YES  
Textures: YES

### DESCRIPTION

CGAxis Models Volume 22 containing 70 highly detailed models of bathrooms appliances. Great for your project, compatible with 3ds max 2008 or higher and many others.

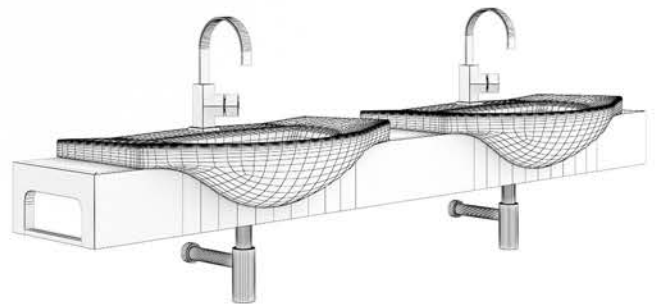

All models, textures, renders, materials, hdri etc. which can be purchased/downloaded from [www.cgaxis.com](http://www.cgaxis.com) are on Royalty-Free non-exclusive license. License is personal and NON transferable. Models, textures, renders, materials, hdri etc. that You have purchased are non-exclusively licensed, NOT sold to You. You can use CGAxis products as a part of a game, if the products are contained inside a propriety format and displays inside the game during play. In this case, you have to add in the producer's section the information that "models by CGAXIS.com". You can sell/resell rendered moving or still images, resold as a part of a feature film, movie advertisement etc. You have a possibility to publish renders in a book, on a poster, t-shirt, magazine, cover or any other item. You have the right to use your renders in every way - charge a fee for them, modify them, to make postproduction etc.



# BATHROOMS

## collection

VOLUME 22

005

### NAME

CGAxis Models Volume 22:  
Bathrooms Collection

### FORMATS

- \*.max (Scanline)
- \*.max (MentalRay)
- \*.max (VRay)
- \*.c4d
- \*.c4d (VRay)
- \*.fbx
- \*.obj

### SPECIFICATION

Total size: 1.68 GB  
Materials: YES  
Textures: YES

### DESCRIPTION

CGAxis Models Volume 22 containing 70 highly detailed models of bathrooms appliances. Great for your project, compatible with 3ds max 2008 or higher and many others.



All models, textures, renders, materials, hdri etc. which can be purchased/downloaded from [www.cgaxis.com](http://www.cgaxis.com) are on Royalty-Free non-exclusive license. License is personal and NON transferable. Models, textures, renders, materials, hdri etc. that You have purchased are non-exclusively licensed, NOT sold to You. You can use CGAxis products as a part of a game, if the products are contained inside a propriety format and displays inside the game during play. In this case, you have to add in the producer's section the information that "models by CGAXIS.com". You can sell/resell rendered moving or still images, resold as a part of a feature film, movie advertisement etc. You have a possibility to publish renders in a book, on a poster, t-shirt, magazine, cover or any other item. You have the right to use your renders in every way - charge a fee for them, modify them, to make postproduction etc.

# BATHROOMS

## collection

VOLUME 22

006

### NAME

CGAxis Models Volume 22:  
Bathrooms Collection

### FORMATS

- \*.max (Scanline)
- \*.max (MentalRay)
- \*.max (VRay)
- \*.c4d
- \*.c4d (VRay)
- \*.fbx
- \*.obj

### SPECIFICATION

Total size: 1.68 GB  
Materials: YES  
Textures: YES

### DESCRIPTION

CGAxis Models Volume 22 containing 70 highly detailed models of bathrooms appliances. Great for your project, compatible with 3ds max 2008 or higher and many others.

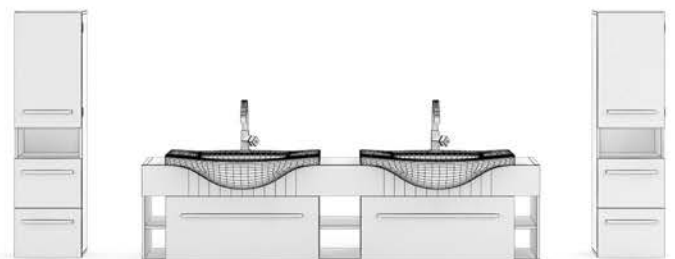

All models, textures, renders, materials, hdri etc. which can be purchased/downloaded from [www.cgaxis.com](http://www.cgaxis.com) are on Royalty-Free non-exclusive license. License is personal and NON transferable. Models, textures, renders, materials, hdri etc. that You have purchased are non-exclusively licensed, NOT sold to You. You can use CGAxis products as a part of a game, if the products are contained inside a propriety format and displays inside the game during play. In this case, you have to add in the producer's section the information that "models by CGAXIS.com". You can sell/resell rendered moving or still images, resold as a part of a feature film, movie advertisement etc. You have a possibility to publish renders in a book, on a poster, t-shirt, magazine, cover or any other item. You have the right to use your renders in every way - charge a fee for them, modify them, to make postproduction etc.

# BATHROOMS

## collection

VOLUME 22

007

### NAME

CGAxis Models Volume 22:  
Bathrooms Collection

### FORMATS

- \*.max (Scanline)
- \*.max (MentalRay)
- \*.max (VRay)
- \*.c4d
- \*.c4d (VRay)
- \*.fbx
- \*.obj

### SPECIFICATION

Total size: 1.68 GB  
Materials: YES  
Textures: YES

### DESCRIPTION

CGAxis Models Volume 22 containing 70 highly detailed models of bathrooms appliances. Great for your project, compatible with 3ds max 2008 or higher and many others.



All models, textures, renders, materials, hdri etc. which can be purchased/downloaded from [www.cgaxis.com](http://www.cgaxis.com) are on Royalty-Free non-exclusive license. License is personal and NON transferable. Models, textures, renders, materials, hdri etc. that You have purchased are non-exclusively licensed, NOT sold to You. You can use CGAxis products as a part of a game, if the products are contained inside a propriety format and displays inside the game during play. In this case, you have to add in the producer's section the information that "models by CGAXIS.com". You can sell/resell rendered moving or still images, resold as a part of a feature film, movie advertisement etc. You have a possibility to publish renders in a book, on a poster, t-shirt, magazine, cover or any other item. You have the right to use your renders in every way - charge a fee for them, modify them, to make postproduction etc.

# BATHROOMS

## collection

VOLUME 22

008

### NAME

CGAxis Models Volume 22:  
Bathrooms Collection

### FORMATS

- \*.max (Scanline)
- \*.max (MentalRay)
- \*.max (VRay)
- \*.c4d
- \*.c4d (VRay)
- \*.fbx
- \*.obj

### SPECIFICATION

Total size: 1.68 GB  
Materials: YES  
Textures: YES

### DESCRIPTION

CGAxis Models Volume 22 containing 70 highly detailed models of bathrooms appliances. Great for your project, compatible with 3ds max 2008 or higher and many others.

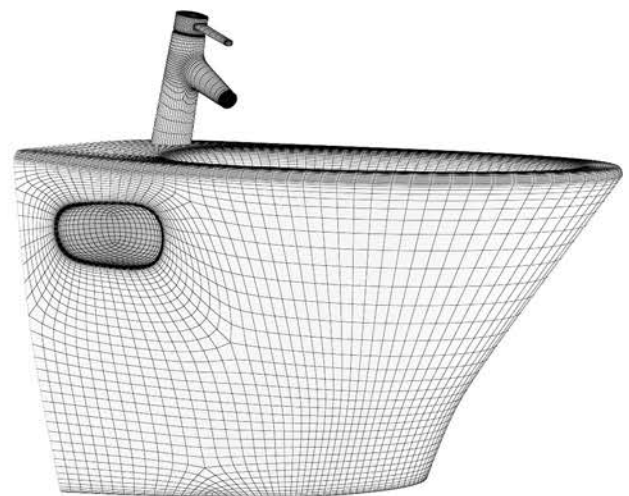

All models, textures, renders, materials, hdri etc. which can be purchased/downloaded from [www.cgaxis.com](http://www.cgaxis.com) are on Royalty-Free non-exclusive license. License is personal and NON transferable. Models, textures, renders, materials, hdri etc. that You have purchased are non-exclusively licensed, NOT sold to You. You can use CGAxis products as a part of a game, if the products are contained inside a propriety format and displays inside the game during play. In this case, you have to add in the producer's section the information that "models by CGAXIS.com". You can sell/resell rendered moving or still images, resold as a part of a feature film, movie advertisement etc. You have a possibility to publish renders in a book, on a poster, t-shirt, magazine, cover or any other item. You have the right to use your renders in every way - charge a fee for them, modify them, to make postproduction etc.

# BATHROOMS

## collection

VOLUME 22

009

### NAME

CGAxis Models Volume 22:  
Bathrooms Collection

### FORMATS

- \*.max (Scanline)
- \*.max (MentalRay)
- \*.max (VRay)
- \*.c4d
- \*.c4d (VRay)
- \*.fbx
- \*.obj

### SPECIFICATION

Total size: 1.68 GB  
Materials: YES  
Textures: YES

### DESCRIPTION

CGAxis Models Volume 22 containing 70 highly detailed models of bathrooms appliances. Great for your project, compatible with 3ds max 2008 or higher and many others.



All models, textures, renders, materials, hdri etc. which can be purchased/downloaded from [www.cgaxis.com](http://www.cgaxis.com) are on Royalty-Free non-exclusive license. License is personal and NON transferable. Models, textures, renders, materials, hdri etc. that You have purchased are non-exclusively licensed, NOT sold to You. You can use CGAxis products as a part of a game, if the products are contained inside a propriety format and displays inside the game during play. In this case, you have to add in the producer's section the information that "models by CGAXIS.com". You can sell/resell rendered moving or still images, resold as a part of a feature film, movie advertisement etc. You have a possibility to publish renders in a book, on a poster, t-shirt, magazine, cover or any other item. You have the right to use your renders in every way - charge a fee for them, modify them, to make postproduction etc.

# BATHROOMS

## collection

VOLUME 22

010

### NAME

CGAxis Models Volume 22:  
Bathrooms Collection

### FORMATS

- \*.max (Scanline)
- \*.max (MentalRay)
- \*.max (VRay)
- \*.c4d
- \*.c4d (VRay)
- \*.fbx
- \*.obj

### SPECIFICATION

Total size: 1.68 GB  
Materials: YES  
Textures: YES

### DESCRIPTION

CGAxis Models Volume 22 containing 70 highly detailed models of bathrooms appliances. Great for your project, compatible with 3ds max 2008 or higher and many others.



All models, textures, renders, materials, hdri etc. which can be purchased/downloaded from [www.cgaxis.com](http://www.cgaxis.com) are on Royalty-Free non-exclusive license. License is personal and NON transferable. Models, textures, renders, materials, hdri etc. that You have purchased are non-exclusively licensed, NOT sold to You. You can use CGAxis products as a part of a game, if the products are contained inside a propriety format and displays inside the game during play. In this case, you have to add in the producer's section the information that "models by CGAXIS.com". You can sell/resell rendered moving or still images, resold as a part of a feature film, movie advertisement etc. You have a possibility to publish renders in a book, on a poster, t-shirt, magazine, cover or any other item. You have the right to use your renders in every way - charge a fee for them, modify them, to make postproduction etc.



# BATHROOMS

## collection

VOLUME 22

011

### NAME

CGAxis Models Volume 22:  
Bathrooms Collection

### FORMATS

- \*.max (Scanline)
- \*.max (MentalRay)
- \*.max (VRay)
- \*.c4d
- \*.c4d (VRay)
- \*.fbx
- \*.obj

### SPECIFICATION

Total size: 1.68 GB  
Materials: YES  
Textures: YES

### DESCRIPTION

CGAxis Models Volume 22 containing 70 highly detailed models of bathrooms appliances. Great for your project, compatible with 3ds max 2008 or higher and many others.



All models, textures, renders, materials, hdri etc. which can be purchased/downloaded from [www.cgaxis.com](http://www.cgaxis.com) are on Royalty-Free non-exclusive license. License is personal and NON transferable. Models, textures, renders, materials, hdri etc. that You have purchased are non-exclusively licensed, NOT sold to You. You can use CGAxis products as a part of a game, if the products are contained inside a propriety format and displays inside the game during play. In this case, you have to add in the producer's section the information that "models by CGAXIS.com". You can sell/resell rendered moving or still images, resold as a part of a feature film, movie advertisement etc. You have a possibility to publish renders in a book, on a poster, t-shirt, magazine, cover or any other item. You have the right to use your renders in every way - charge a fee for them, modify them, to make postproduction etc.

# BATHROOMS

## collection

VOLUME 22

012

### NAME

CGAxis Models Volume 22:  
Bathrooms Collection

### FORMATS

- \*.max (Scanline)
- \*.max (MentalRay)
- \*.max (VRay)
- \*.c4d
- \*.c4d (VRay)
- \*.fbx
- \*.obj

### SPECIFICATION

Total size: 1.68 GB  
Materials: YES  
Textures: YES

### DESCRIPTION

CGAxis Models Volume 22 containing 70 highly detailed models of bathrooms appliances. Great for your project, compatible with 3ds max 2008 or higher and many others.

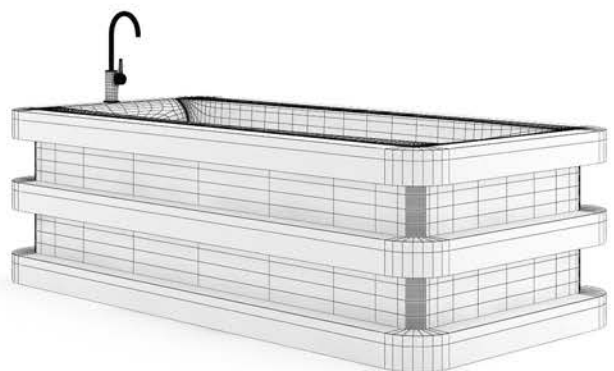

All models, textures, renders, materials, hdri etc. which can be purchased/downloaded from [www.cgaxis.com](http://www.cgaxis.com) are on Royalty-Free non-exclusive license. License is personal and NON transferable. Models, textures, renders, materials, hdri etc. that You have purchased are non-exclusively licensed, NOT sold to You. You can use CGAxis products as a part of a game, if the products are contained inside a propriety format and displays inside the game during play. In this case, you have to add in the producer's section the information that "models by CGAXIS.com". You can sell/resell rendered moving or still images, resold as a part of a feature film, movie advertisement etc. You have a possibility to publish renders in a book, on a poster, t-shirt, magazine, cover or any other item. You have the right to use your renders in every way - charge a fee for them, modify them, to make postproduction etc.

# BATHROOMS

## collection

VOLUME 22

013

### NAME

CGAxis Models Volume 22:  
Bathrooms Collection

### FORMATS

- \*.max (Scanline)
- \*.max (MentalRay)
- \*.max (VRay)
- \*.c4d
- \*.c4d (VRay)
- \*.fbx
- \*.obj

### SPECIFICATION

Total size: 1.68 GB  
Materials: YES  
Textures: YES

### DESCRIPTION

CGAxis Models Volume 22 containing 70 highly detailed models of bathrooms appliances. Great for your project, compatible with 3ds max 2008 or higher and many others.

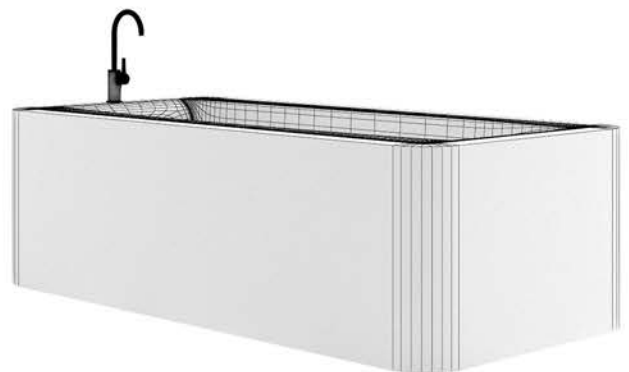

All models, textures, renders, materials, hdri etc. which can be purchased/downloaded from [www.cgaxis.com](http://www.cgaxis.com) are on Royalty-Free non-exclusive license. License is personal and NON transferable. Models, textures, renders, materials, hdri etc. that You have purchased are non-exclusively licensed, NOT sold to You. You can use CGAxis products as a part of a game, if the products are contained inside a propriety format and displays inside the game during play. In this case, you have to add in the producer's section the information that "models by CGAXIS.com". You can sell/resell rendered moving or still images, resold as a part of a feature film, movie advertisement etc. You have a possibility to publish renders in a book, on a poster, t-shirt, magazine, cover or any other item. You have the right to use your renders in every way - charge a fee for them, modify them, to make postproduction etc.

# BATHROOMS

## collection

VOLUME 22

014

### NAME

CGAxis Models Volume 22:  
Bathrooms Collection

### FORMATS

- \*.max (Scanline)
- \*.max (MentalRay)
- \*.max (VRay)
- \*.c4d
- \*.c4d (VRay)
- \*.fbx
- \*.obj

### SPECIFICATION

Total size: 1.68 GB  
Materials: YES  
Textures: YES

### DESCRIPTION

CGAxis Models Volume 22 containing 70 highly detailed models of bathrooms appliances. Great for your project, compatible with 3ds max 2008 or higher and many others.

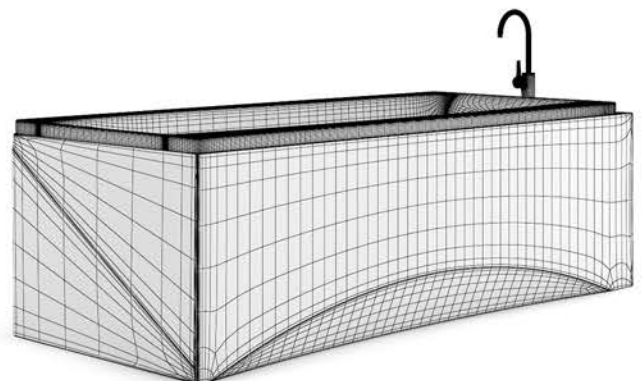

All models, textures, renders, materials, hdri etc. which can be purchased/downloaded from [www.cgaxis.com](http://www.cgaxis.com) are on Royalty-Free non-exclusive license. License is personal and NON transferable. Models, textures, renders, materials, hdri etc. that You have purchased are non-exclusively licensed, NOT sold to You. You can use CGAxis products as a part of a game, if the products are contained inside a propriety format and displays inside the game during play. In this case, you have to add in the producer's section the information that "models by CGAXIS.com". You can sell/resell rendered moving or still images, resold as a part of a feature film, movie advertisement etc. You have a possibility to publish renders in a book, on a poster, t-shirt, magazine, cover or any other item. You have the right to use your renders in every way - charge a fee for them, modify them, to make postproduction etc.

# BATHROOMS

## collection

VOLUME 22

015

### NAME

CGAxis Models Volume 22:  
Bathrooms Collection

### FORMATS

- \*.max (Scanline)
- \*.max (MentalRay)
- \*.max (VRay)
- \*.c4d
- \*.c4d (VRay)
- \*.fbx
- \*.obj

### SPECIFICATION

Total size: 1.68 GB  
Materials: YES  
Textures: YES

### DESCRIPTION

CGAxis Models Volume 22 containing 70 highly detailed models of bathrooms appliances. Great for your project, compatible with 3ds max 2008 or higher and many others.



All models, textures, renders, materials, hdri etc. which can be purchased/downloaded from [www.cgaxis.com](http://www.cgaxis.com) are on Royalty-Free non-exclusive license. License is personal and NON transferable. Models, textures, renders, materials, hdri etc. that You have purchased are non-exclusively licensed, NOT sold to You. You can use CGAxis products as a part of a game, if the products are contained inside a propriety format and displays inside the game during play. In this case, you have to add in the producer's section the information that "models by CGAXIS.com". You can sell/resell rendered moving or still images, resold as a part of a feature film, movie advertisement etc. You have a possibility to publish renders in a book, on a poster, t-shirt, magazine, cover or any other item. You have the right to use your renders in every way - charge a fee for them, modify them, to make postproduction etc.

# BATHROOMS

## collection

VOLUME 22

016

### NAME

CGAxis Models Volume 22:  
Bathrooms Collection

### FORMATS

- \*.max (Scanline)
- \*.max (MentalRay)
- \*.max (VRay)
- \*.c4d
- \*.c4d (VRay)
- \*.fbx
- \*.obj

### SPECIFICATION

Total size: 1.68 GB  
Materials: YES  
Textures: YES

### DESCRIPTION

CGAxis Models Volume 22 containing 70 highly detailed models of bathrooms appliances. Great for your project, compatible with 3ds max 2008 or higher and many others.

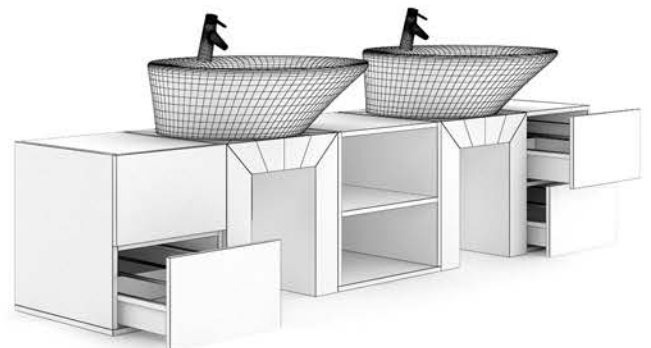

All models, textures, renders, materials, hdri etc. which can be purchased/downloaded from [www.cgaxis.com](http://www.cgaxis.com) are on Royalty-Free non-exclusive license. License is personal and NON transferable. Models, textures, renders, materials, hdri etc. that You have purchased are non-exclusively licensed, NOT sold to You. You can use CGAxis products as a part of a game, if the products are contained inside a propriety format and displays inside the game during play. In this case, you have to add in the producer's section the information that "models by CGAXIS.com". You can sell/resell rendered moving or still images, resold as a part of a feature film, movie advertisement etc. You have a possibility to publish renders in a book, on a poster, t-shirt, magazine, cover or any other item. You have the right to use your renders in every way - charge a fee for them, modify them, to make postproduction etc.



# BATHROOMS

## collection

VOLUME 22

017

### NAME

CGAxis Models Volume 22:  
Bathrooms Collection

### FORMATS

- \*.max (Scanline)
- \*.max (MentalRay)
- \*.max (VRay)
- \*.c4d
- \*.c4d (VRay)
- \*.fbx
- \*.obj

### SPECIFICATION

Total size: 1.68 GB  
Materials: YES  
Textures: YES

### DESCRIPTION

CGAxis Models Volume 22 containing 70 highly detailed models of bathrooms appliances. Great for your project, compatible with 3ds max 2008 or higher and many others.



All models, textures, renders, materials, hdri etc. which can be purchased/downloaded from [www.cgaxis.com](http://www.cgaxis.com) are on Royalty-Free non-exclusive license. License is personal and NON transferable. Models, textures, renders, materials, hdri etc. that You have purchased are non-exclusively licensed, NOT sold to You. You can use CGAxis products as a part of a game, if the products are contained inside a propriety format and displays inside the game during play. In this case, you have to add in the producer's section the information that "models by CGAXIS.com". You can sell/resell rendered moving or still images, resold as a part of a feature film, movie advertisement etc. You have a possibility to publish renders in a book, on a poster, t-shirt, magazine, cover or any other item. You have the right to use your renders in every way - charge a fee for them, modify them, to make postproduction etc.

# BATHROOMS

## collection

VOLUME 22

018

### NAME

CGAxis Models Volume 22:  
Bathrooms Collection

### FORMATS

- \*.max (Scanline)
- \*.max (MentalRay)
- \*.max (VRay)
- \*.c4d
- \*.c4d (VRay)
- \*.fbx
- \*.obj

### SPECIFICATION

Total size: 1.68 GB  
Materials: YES  
Textures: YES

### DESCRIPTION

CGAxis Models Volume 22 containing 70 highly detailed models of bathrooms appliances. Great for your project, compatible with 3ds max 2008 or higher and many others.



All models, textures, renders, materials, hdri etc. which can be purchased/downloaded from [www.cgaxis.com](http://www.cgaxis.com) are on Royalty-Free non-exclusive license. License is personal and NON transferable. Models, textures, renders, materials, hdri etc. that You have purchased are non-exclusively licensed, NOT sold to You. You can use CGAxis products as a part of a game, if the products are contained inside a propriety format and displays inside the game during play. In this case, you have to add in the producer's section the information that "models by CGAXIS.com". You can sell/resell rendered moving or still images, resold as a part of a feature film, movie advertisement etc. You have a possibility to publish renders in a book, on a poster, t-shirt, magazine, cover or any other item. You have the right to use your renders in every way - charge a fee for them, modify them, to make postproduction etc.

# BATHROOMS

## collection

VOLUME 22

019

### NAME

CGAxis Models Volume 22:  
Bathrooms Collection

### FORMATS

- \*.max (Scanline)
- \*.max (MentalRay)
- \*.max (VRay)
- \*.c4d
- \*.c4d (VRay)
- \*.fbx
- \*.obj

### SPECIFICATION

Total size: 1.68 GB  
Materials: YES  
Textures: YES

### DESCRIPTION

CGAxis Models Volume 22 containing 70 highly detailed models of bathrooms appliances. Great for your project, compatible with 3ds max 2008 or higher and many others.



All models, textures, renders, materials, hdri etc. which can be purchased/downloaded from [www.cgaxis.com](http://www.cgaxis.com) are on Royalty-Free non-exclusive license. License is personal and NON transferable. Models, textures, renders, materials, hdri etc. that You have purchased are non-exclusively licensed, NOT sold to You. You can use CGAxis products as a part of a game, if the products are contained inside a propriety format and displays inside the game during play. In this case, you have to add in the producer's section the information that "models by CGAXIS.com". You can sell/resell rendered moving or still images, resold as a part of a feature film, movie advertisement etc. You have a possibility to publish renders in a book, on a poster, t-shirt, magazine, cover or any other item. You have the right to use your renders in every way - charge a fee for them, modify them, to make postproduction etc.

# BATHROOMS

## collection

VOLUME 22

020

### NAME

CGAxis Models Volume 22:  
Bathrooms Collection

### FORMATS

- \*.max (Scanline)
- \*.max (MentalRay)
- \*.max (VRay)
- \*.c4d
- \*.c4d (VRay)
- \*.fbx
- \*.obj

### SPECIFICATION

Total size: 1.68 GB  
Materials: YES  
Textures: YES

### DESCRIPTION

CGAxis Models Volume 22 containing 70 highly detailed models of bathrooms appliances. Great for your project, compatible with 3ds max 2008 or higher and many others.



All models, textures, renders, materials, hdri etc. which can be purchased/downloaded from [www.cgaxis.com](http://www.cgaxis.com) are on Royalty-Free non-exclusive license. License is personal and NON transferable. Models, textures, renders, materials, hdri etc. that You have purchased are non-exclusively licensed, NOT sold to You. You can use CGAxis products as a part of a game, if the products are contained inside a propriety format and displays inside the game during play. In this case, you have to add in the producer's section the information that "models by CGAXIS.com". You can sell/resell rendered moving or still images, resold as a part of a feature film, movie advertisement etc. You have a possibility to publish renders in a book, on a poster, t-shirt, magazine, cover or any other item. You have the right to use your renders in every way - charge a fee for them, modify them, to make postproduction etc.

# BATHROOMS

## collection

VOLUME 22

021

### NAME

CGAxis Models Volume 22:  
Bathrooms Collection

### FORMATS

- \*.max (Scanline)
- \*.max (MentalRay)
- \*.max (VRay)
- \*.c4d
- \*.c4d (VRay)
- \*.fbx
- \*.obj

### SPECIFICATION

Total size: 1.68 GB  
Materials: YES  
Textures: YES

### DESCRIPTION

CGAxis Models Volume 22 containing 70 highly detailed models of bathrooms appliances. Great for your project, compatible with 3ds max 2008 or higher and many others.

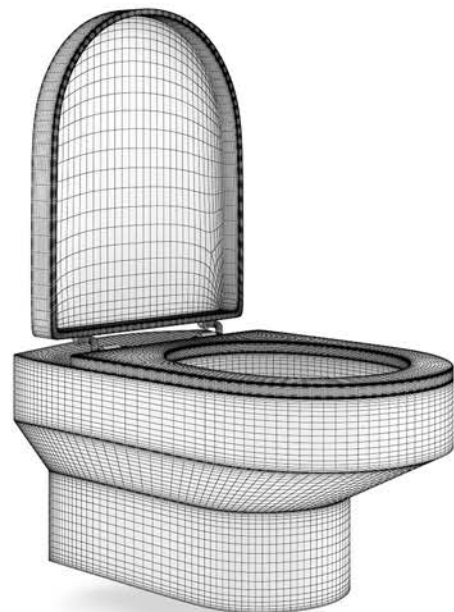

All models, textures, renders, materials, hdri etc. which can be purchased/downloaded from [www.cgaxis.com](http://www.cgaxis.com) are on Royalty-Free non-exclusive license. License is personal and NON transferable. Models, textures, renders, materials, hdri etc. that You have purchased are non-exclusively licensed, NOT sold to You. You can use CGAxis products as a part of a game, if the products are contained inside a propriety format and displays inside the game during play. In this case, you have to add in the producer's section the information that "models by CGAXIS.com". You can sell/resell rendered moving or still images, resold as a part of a feature film, movie advertisement etc. You have a possibility to publish renders in a book, on a poster, t-shirt, magazine, cover or any other item. You have the right to use your renders in every way - charge a fee for them, modify them, to make postproduction etc.

# BATHROOMS

## collection

VOLUME 22

022

### NAME

CGAxis Models Volume 22:  
Bathrooms Collection

### FORMATS

- \*.max (Scanline)
- \*.max (MentalRay)
- \*.max (VRay)
- \*.c4d
- \*.c4d (VRay)
- \*.fbx
- \*.obj

### SPECIFICATION

Total size: 1.68 GB  
Materials: YES  
Textures: YES

### DESCRIPTION

CGAxis Models Volume 22 containing 70 highly detailed models of bathrooms appliances. Great for your project, compatible with 3ds max 2008 or higher and many others.



All models, textures, renders, materials, hdri etc. which can be purchased/downloaded from [www.cgaxis.com](http://www.cgaxis.com) are on Royalty-Free non-exclusive license. License is personal and NON transferable. Models, textures, renders, materials, hdri etc. that You have purchased are non-exclusively licensed, NOT sold to You. You can use CGAxis products as a part of a game, if the products are contained inside a propriety format and displays inside the game during play. In this case, you have to add in the producer's section the information that "models by CGAXIS.com". You can sell/resell rendered moving or still images, resold as a part of a feature film, movie advertisement etc. You have a possibility to publish renders in a book, on a poster, t-shirt, magazine, cover or any other item. You have the right to use your renders in every way - charge a fee for them, modify them, to make postproduction etc.



# BATHROOMS

## collection

VOLUME 22

023

### NAME

CGAxis Models Volume 22:  
Bathrooms Collection

### FORMATS

- \*.max (Scanline)
- \*.max (MentalRay)
- \*.max (VRay)
- \*.c4d
- \*.c4d (VRay)
- \*.fbx
- \*.obj

### SPECIFICATION

Total size: 1.68 GB  
Materials: YES  
Textures: YES

### DESCRIPTION

CGAxis Models Volume 22 containing 70 highly detailed models of bathrooms appliances. Great for your project, compatible with 3ds max 2008 or higher and many others.



All models, textures, renders, materials, hdri etc. which can be purchased/downloaded from [www.cgaxis.com](http://www.cgaxis.com) are on Royalty-Free non-exclusive license. License is personal and NON transferable. Models, textures, renders, materials, hdri etc. that You have purchased are non-exclusively licensed, NOT sold to You. You can use CGAxis products as a part of a game, if the products are contained inside a propriety format and displays inside the game during play. In this case, you have to add in the producer's section the information that "models by CGAXIS.com". You can sell/resell rendered moving or still images, resold as a part of a feature film, movie advertisement etc. You have a possibility to publish renders in a book, on a poster, t-shirt, magazine, cover or any other item. You have the right to use your renders in every way - charge a fee for them, modify them, to make postproduction etc.

# BATHROOMS

## collection

VOLUME 22

024

### NAME

CGAxis Models Volume 22:  
Bathrooms Collection

### FORMATS

- \*.max (Scanline)
- \*.max (MentalRay)
- \*.max (VRay)
- \*.c4d
- \*.c4d (VRay)
- \*.fbx
- \*.obj

### SPECIFICATION

Total size: 1.68 GB  
Materials: YES  
Textures: YES

### DESCRIPTION

CGAxis Models Volume 22 containing 70 highly detailed models of bathrooms appliances. Great for your project, compatible with 3ds max 2008 or higher and many others.

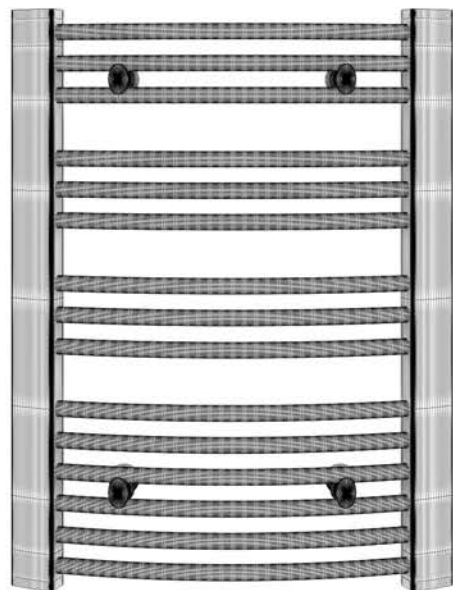

All models, textures, renders, materials, hdri etc. which can be purchased/downloaded from [www.cgaxis.com](http://www.cgaxis.com) are on Royalty-Free non-exclusive license. License is personal and NON transferable. Models, textures, renders, materials, hdri etc. that You have purchased are non-exclusively licensed, NOT sold to You. You can use CGAxis products as a part of a game, if the products are contained inside a propriety format and displays inside the game during play. In this case, you have to add in the producer's section the information that "models by CGAXIS.com". You can sell/resell rendered moving or still images, resold as a part of a feature film, movie advertisement etc. You have a possibility to publish renders in a book, on a poster, t-shirt, magazine, cover or any other item. You have the right to use your renders in every way - charge a fee for them, modify them, to make postproduction etc.

# BATHROOMS

## collection

VOLUME 22

025

### NAME

CGAxis Models Volume 22:  
Bathrooms Collection

### FORMATS

- \*.max (Scanline)
- \*.max (MentalRay)
- \*.max (VRay)
- \*.c4d
- \*.c4d (VRay)
- \*.fbx
- \*.obj

### SPECIFICATION

Total size: 1.68 GB  
Materials: YES  
Textures: YES

### DESCRIPTION

CGAxis Models Volume 22 containing 70 highly detailed models of bathrooms appliances. Great for your project, compatible with 3ds max 2008 or higher and many others.

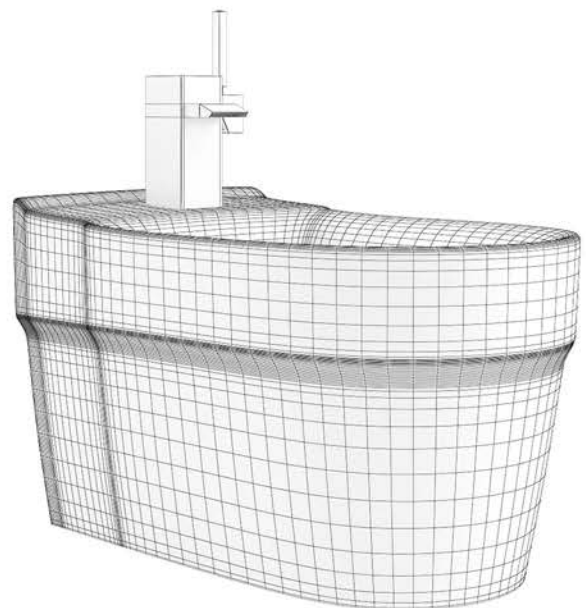

All models, textures, renders, materials, hdri etc. which can be purchased/downloaded from [www.cgaxis.com](http://www.cgaxis.com) are on Royalty-Free non-exclusive license. License is personal and NON transferable. Models, textures, renders, materials, hdri etc. that You have purchased are non-exclusively licensed, NOT sold to You. You can use CGAxis products as a part of a game, if the products are contained inside a propriety format and displays inside the game during play. In this case, you have to add in the producer's section the information that "models by CGAXIS.com". You can sell/resell rendered moving or still images, resold as a part of a feature film, movie advertisement etc. You have a possibility to publish renders in a book, on a poster, t-shirt, magazine, cover or any other item. You have the right to use your renders in every way - charge a fee for them, modify them, to make postproduction etc.

# BATHROOMS

## collection

VOLUME 22

026

### NAME

CGAxis Models Volume 22:  
Bathrooms Collection

### FORMATS

- \*.max (Scanline)
- \*.max (MentalRay)
- \*.max (VRay)
- \*.c4d
- \*.c4d (VRay)
- \*.fbx
- \*.obj

### SPECIFICATION

Total size: 1.68 GB  
Materials: YES  
Textures: YES

### DESCRIPTION

CGAxis Models Volume 22 containing 70 highly detailed models of bathrooms appliances. Great for your project, compatible with 3ds max 2008 or higher and many others.



All models, textures, renders, materials, hdri etc. which can be purchased/downloaded from [www.cgaxis.com](http://www.cgaxis.com) are on Royalty-Free non-exclusive license. License is personal and NON transferable. Models, textures, renders, materials, hdri etc. that You have purchased are non-exclusively licensed, NOT sold to You. You can use CGAxis products as a part of a game, if the products are contained inside a propriety format and displays inside the game during play. In this case, you have to add in the producer's section the information that "models by CGAXIS.com". You can sell/resell rendered moving or still images, resold as a part of a feature film, movie advertisement etc. You have a possibility to publish renders in a book, on a poster, t-shirt, magazine, cover or any other item. You have the right to use your renders in every way - charge a fee for them, modify them, to make postproduction etc.

# BATHROOMS

## collection

VOLUME 22

027

### NAME

CGAxis Models Volume 22:  
Bathrooms Collection

### FORMATS

\*.max (Scanline)  
\*.max (MentalRay)  
\*.max (VRay)  
\*.c4d  
\*.c4d (VRay)  
\*.fbx  
\*.obj

### SPECIFICATION

Total size: 1.68 GB  
Materials: YES  
Textures: YES

### DESCRIPTION

CGAxis Models Volume 22 containing 70 highly detailed models of bathrooms appliances. Great for your project, compatible with 3ds max 2008 or higher and many others.

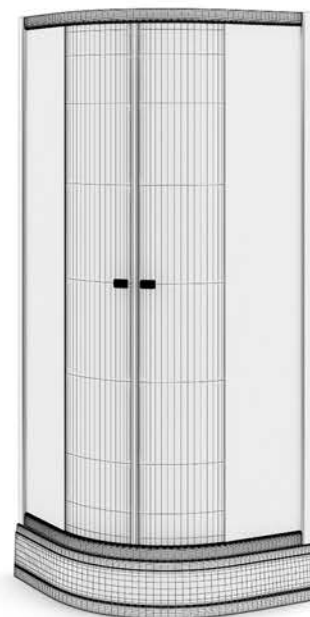

All models, textures, renders, materials, hdri etc. which can be purchased/downloaded from [www.cgaxis.com](http://www.cgaxis.com) are on Royalty-Free non-exclusive license. License is personal and NON transferable. Models, textures, renders, materials, hdri etc. that You have purchased are non-exclusively licensed, NOT sold to You. You can use CGAxis products as a part of a game, if the products are contained inside a propriety format and displays inside the game during play. In this case, you have to add in the producer's section the information that "models by CGAXIS.com". You can sell/resell rendered moving or still images, resold as a part of a feature film, movie advertisement etc. You have a possibility to publish renders in a book, on a poster, t-shirt, magazine, cover or any other item. You have the right to use your renders in every way - charge a fee for them, modify them, to make postproduction etc.

# BATHROOMS

## collection

VOLUME 22

028

### NAME

CGAxis Models Volume 22:  
Bathrooms Collection

### FORMATS

- \*.max (Scanline)
- \*.max (MentalRay)
- \*.max (VRay)
- \*.c4d
- \*.c4d (VRay)
- \*.fbx
- \*.obj

### SPECIFICATION

Total size: 1.68 GB  
Materials: YES  
Textures: YES

### DESCRIPTION

CGAxis Models Volume 22 containing 70 highly detailed models of bathrooms appliances. Great for your project, compatible with 3ds max 2008 or higher and many others.



All models, textures, renders, materials, hdri etc. which can be purchased/downloaded from [www.cgaxis.com](http://www.cgaxis.com) are on Royalty-Free non-exclusive license. License is personal and NON transferable. Models, textures, renders, materials, hdri etc. that You have purchased are non-exclusively licensed, NOT sold to You. You can use CGAxis products as a part of a game, if the products are contained inside a propriety format and displays inside the game during play. In this case, you have to add in the producer's section the information that "models by CGAXIS.com". You can sell/resell rendered moving or still images, resold as a part of a feature film, movie advertisement etc. You have a possibility to publish renders in a book, on a poster, t-shirt, magazine, cover or any other item. You have the right to use your renders in every way - charge a fee for them, modify them, to make postproduction etc.



# BATHROOMS

## collection

VOLUME 22

029

### NAME

CGAxis Models Volume 22:  
Bathrooms Collection

### FORMATS

- \*.max (Scanline)
- \*.max (MentalRay)
- \*.max (VRay)
- \*.c4d
- \*.c4d (VRay)
- \*.fbx
- \*.obj

### SPECIFICATION

Total size: 1.68 GB  
Materials: YES  
Textures: YES

### DESCRIPTION

CGAxis Models Volume 22 containing 70 highly detailed models of bathrooms appliances. Great for your project, compatible with 3ds max 2008 or higher and many others.



All models, textures, renders, materials, hdri etc. which can be purchased/downloaded from [www.cgaxis.com](http://www.cgaxis.com) are on Royalty-Free non-exclusive license. License is personal and NON transferable. Models, textures, renders, materials, hdri etc. that You have purchased are non-exclusively licensed, NOT sold to You. You can use CGAxis products as a part of a game, if the products are contained inside a propriety format and displays inside the game during play. In this case, you have to add in the producer's section the information that "models by CGAXIS.com". You can sell/resell rendered moving or still images, resold as a part of a feature film, movie advertisement etc. You have a possibility to publish renders in a book, on a poster, t-shirt, magazine, cover or any other item. You have the right to use your renders in every way - charge a fee for them, modify them, to make postproduction etc.

# BATHROOMS

## collection

VOLUME 22

030

### NAME

CGAxis Models Volume 22:  
Bathrooms Collection

### FORMATS

- \*.max (Scanline)
- \*.max (MentalRay)
- \*.max (VRay)
- \*.c4d
- \*.c4d (VRay)
- \*.fbx
- \*.obj

### SPECIFICATION

Total size: 1.68 GB  
Materials: YES  
Textures: YES

### DESCRIPTION

CGAxis Models Volume 22 containing 70 highly detailed models of bathrooms appliances. Great for your project, compatible with 3ds max 2008 or higher and many others.

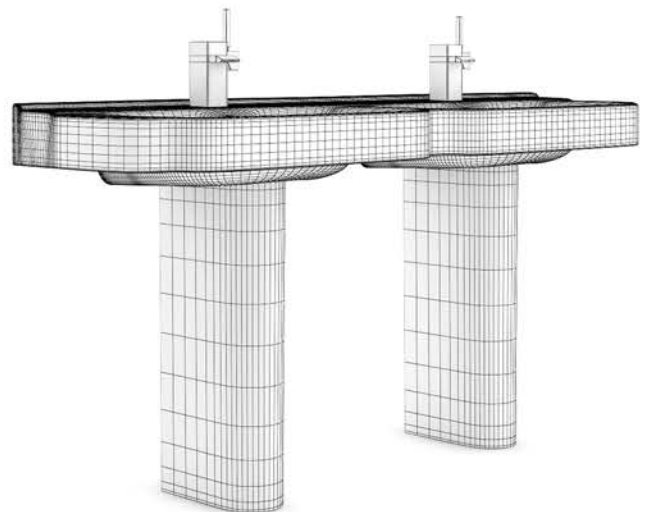

All models, textures, renders, materials, hdri etc. which can be purchased/downloaded from [www.cgaxis.com](http://www.cgaxis.com) are on Royalty-Free non-exclusive license. License is personal and NON transferable. Models, textures, renders, materials, hdri etc. that You have purchased are non-exclusively licensed, NOT sold to You. You can use CGAxis products as a part of a game, if the products are contained inside a propriety format and displays inside the game during play. In this case, you have to add in the producer's section the information that "models by CGAXIS.com". You can sell/resell rendered moving or still images, resold as a part of a feature film, movie advertisement etc. You have a possibility to publish renders in a book, on a poster, t-shirt, magazine, cover or any other item. You have the right to use your renders in every way - charge a fee for them, modify them, to make postproduction etc.

# BATHROOMS

## collection

VOLUME 22

031

### NAME

CGAxis Models Volume 22:  
Bathrooms Collection

### FORMATS

- \*.max (Scanline)
- \*.max (MentalRay)
- \*.max (VRay)
- \*.c4d
- \*.c4d (VRay)
- \*.fbx
- \*.obj

### SPECIFICATION

Total size: 1.68 GB  
Materials: YES  
Textures: YES

### DESCRIPTION

CGAxis Models Volume 22 containing 70 highly detailed models of bathrooms appliances. Great for your project, compatible with 3ds max 2008 or higher and many others.

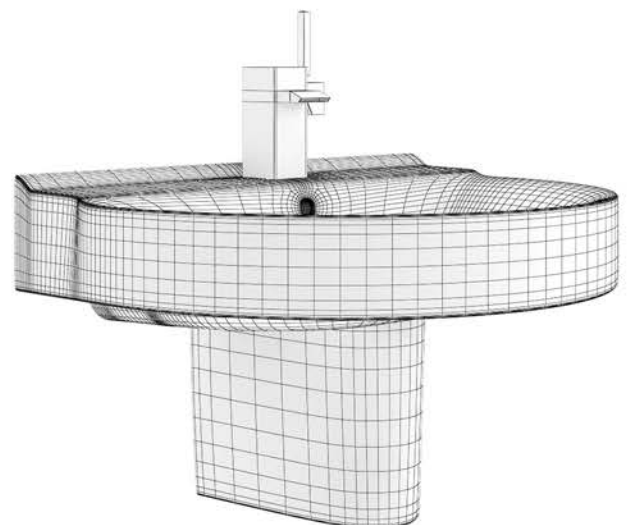

All models, textures, renders, materials, hdri etc. which can be purchased/downloaded from [www.cgaxis.com](http://www.cgaxis.com) are on Royalty-Free non-exclusive license. License is personal and NON transferable. Models, textures, renders, materials, hdri etc. that You have purchased are non-exclusively licensed, NOT sold to You. You can use CGAxis products as a part of a game, if the products are contained inside a propriety format and displays inside the game during play. In this case, you have to add in the producer's section the information that "models by CGAXIS.com". You can sell/resell rendered moving or still images, resold as a part of a feature film, movie advertisement etc. You have a possibility to publish renders in a book, on a poster, t-shirt, magazine, cover or any other item. You have the right to use your renders in every way - charge a fee for them, modify them, to make postproduction etc.

# BATHROOMS

## collection

VOLUME 22

032

### NAME

CGAxis Models Volume 22:  
Bathrooms Collection

### FORMATS

- \*.max (Scanline)
- \*.max (MentalRay)
- \*.max (VRay)
- \*.c4d
- \*.c4d (VRay)
- \*.fbx
- \*.obj

### SPECIFICATION

Total size: 1.68 GB  
Materials: YES  
Textures: YES

### DESCRIPTION

CGAxis Models Volume 22 containing 70 highly detailed models of bathrooms appliances. Great for your project, compatible with 3ds max 2008 or higher and many others.

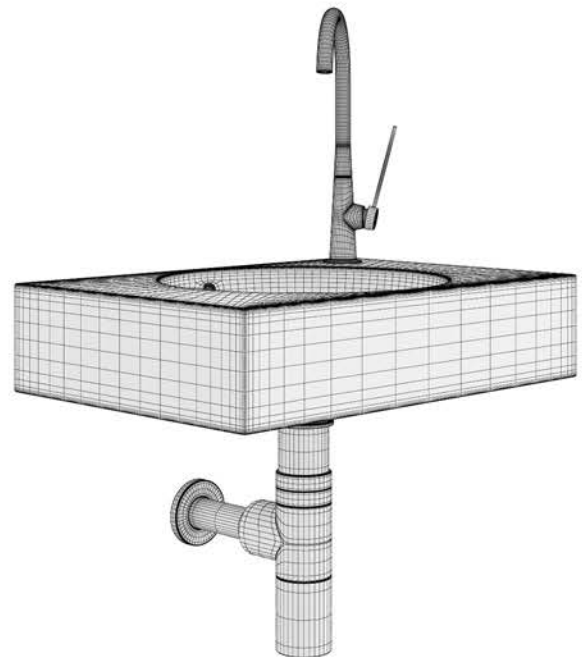

All models, textures, renders, materials, hdri etc. which can be purchased/downloaded from [www.cgaxis.com](http://www.cgaxis.com) are on Royalty-Free non-exclusive license. License is personal and NON transferable. Models, textures, renders, materials, hdri etc. that You have purchased are non-exclusively licensed, NOT sold to You. You can use CGAxis products as a part of a game, if the products are contained inside a propriety format and displays inside the game during play. In this case, you have to add in the producer's section the information that "models by CGAXIS.com". You can sell/resell rendered moving or still images, resold as a part of a feature film, movie advertisement etc. You have a possibility to publish renders in a book, on a poster, t-shirt, magazine, cover or any other item. You have the right to use your renders in every way - charge a fee for them, modify them, to make postproduction etc.

# BATHROOMS

## collection

VOLUME 22

033

### NAME

CGAxis Models Volume 22:  
Bathrooms Collection

### FORMATS

- \*.max (Scanline)
- \*.max (MentalRay)
- \*.max (VRay)
- \*.c4d
- \*.c4d (VRay)
- \*.fbx
- \*.obj

### SPECIFICATION

Total size: 1.68 GB  
Materials: YES  
Textures: YES

### DESCRIPTION

CGAxis Models Volume 22 containing 70 highly detailed models of bathrooms appliances. Great for your project, compatible with 3ds max 2008 or higher and many others.

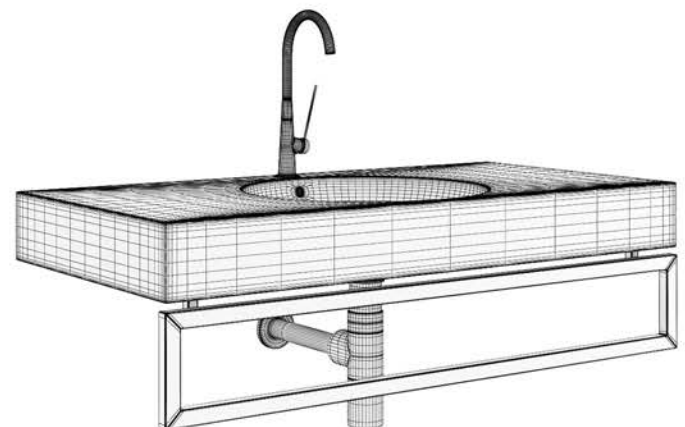

All models, textures, renders, materials, hdri etc. which can be purchased/downloaded from [www.cgaxis.com](http://www.cgaxis.com) are on Royalty-Free non-exclusive license. License is personal and NON transferable. Models, textures, renders, materials, hdri etc. that You have purchased are non-exclusively licensed, NOT sold to You. You can use CGAxis products as a part of a game, if the products are contained inside a propriety format and displays inside the game during play. In this case, you have to add in the producer's section the information that "models by CGAXIS.com". You can sell/resell rendered moving or still images, resold as a part of a feature film, movie advertisement etc. You have a possibility to publish renders in a book, on a poster, t-shirt, magazine, cover or any other item. You have the right to use your renders in every way - charge a fee for them, modify them, to make postproduction etc.

# BATHROOMS

## collection

VOLUME 22

034

### NAME

CGAxis Models Volume 22:  
Bathrooms Collection

### FORMATS

- \*.max (Scanline)
- \*.max (MentalRay)
- \*.max (VRay)
- \*.c4d
- \*.c4d (VRay)
- \*.fbx
- \*.obj

### SPECIFICATION

Total size: 1.68 GB  
Materials: YES  
Textures: YES

### DESCRIPTION

CGAxis Models Volume 22 containing 70 highly detailed models of bathrooms appliances. Great for your project, compatible with 3ds max 2008 or higher and many others.

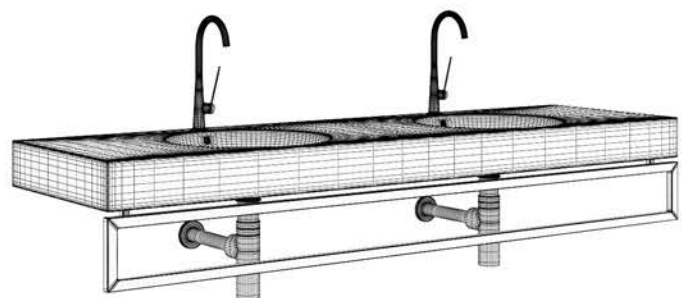

All models, textures, renders, materials, hdri etc. which can be purchased/downloaded from [www.cgaxis.com](http://www.cgaxis.com) are on Royalty-Free non-exclusive license. License is personal and NON transferable. Models, textures, renders, materials, hdri etc. that You have purchased are non-exclusively licensed, NOT sold to You. You can use CGAxis products as a part of a game, if the products are contained inside a propriety format and displays inside the game during play. In this case, you have to add in the producer's section the information that "models by CGAXIS.com". You can sell/resell rendered moving or still images, resold as a part of a feature film, movie advertisement etc. You have a possibility to publish renders in a book, on a poster, t-shirt, magazine, cover or any other item. You have the right to use your renders in every way - charge a fee for them, modify them, to make postproduction etc.



# BATHROOMS

## collection

VOLUME 22

035

### NAME

CGAxis Models Volume 22:  
Bathrooms Collection

### FORMATS

- \*.max (Scanline)
- \*.max (MentalRay)
- \*.max (VRay)
- \*.c4d
- \*.c4d (VRay)
- \*.fbx
- \*.obj

### SPECIFICATION

Total size: 1.68 GB  
Materials: YES  
Textures: YES

### DESCRIPTION

CGAxis Models Volume 22 containing 70 highly detailed models of bathrooms appliances. Great for your project, compatible with 3ds max 2008 or higher and many others.

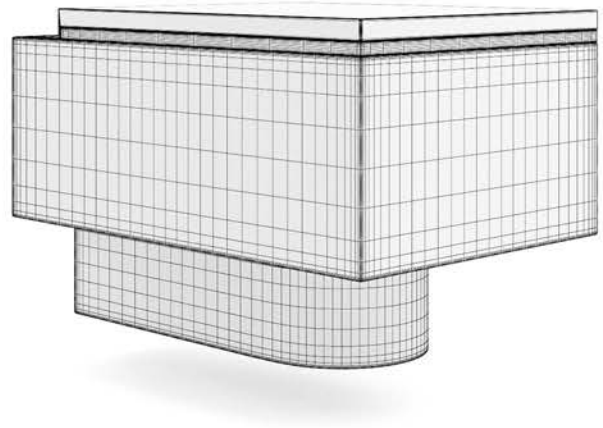

All models, textures, renders, materials, hdri etc. which can be purchased/downloaded from [www.cgaxis.com](http://www.cgaxis.com) are on Royalty-Free non-exclusive license. License is personal and NON transferable. Models, textures, renders, materials, hdri etc. that You have purchased are non-exclusively licensed, NOT sold to You. You can use CGAxis products as a part of a game, if the products are contained inside a propriety format and displays inside the game during play. In this case, you have to add in the producer's section the information that "models by CGAXIS.com". You can sell/resell rendered moving or still images, resold as a part of a feature film, movie advertisement etc. You have a possibility to publish renders in a book, on a poster, t-shirt, magazine, cover or any other item. You have the right to use your renders in every way - charge a fee for them, modify them, to make postproduction etc.

# BATHROOMS

## collection

VOLUME 22

036

### NAME

CGAxis Models Volume 22:  
Bathrooms Collection

### FORMATS

- \*.max (Scanline)
- \*.max (MentalRay)
- \*.max (VRay)
- \*.c4d
- \*.c4d (VRay)
- \*.fbx
- \*.obj

### SPECIFICATION

Total size: 1.68 GB  
Materials: YES  
Textures: YES

### DESCRIPTION

CGAxis Models Volume 22 containing 70 highly detailed models of bathrooms appliances. Great for your project, compatible with 3ds max 2008 or higher and many others.



All models, textures, renders, materials, hdri etc. which can be purchased/downloaded from [www.cgaxis.com](http://www.cgaxis.com) are on Royalty-Free non-exclusive license. License is personal and NON transferable. Models, textures, renders, materials, hdri etc. that You have purchased are non-exclusively licensed, NOT sold to You. You can use CGAxis products as a part of a game, if the products are contained inside a propriety format and displays inside the game during play. In this case, you have to add in the producer's section the information that "models by CGAXIS.com". You can sell/resell rendered moving or still images, resold as a part of a feature film, movie advertisement etc. You have a possibility to publish renders in a book, on a poster, t-shirt, magazine, cover or any other item. You have the right to use your renders in every way - charge a fee for them, modify them, to make postproduction etc.

# BATHROOMS

## collection

VOLUME 22

037

### NAME

CGAxis Models Volume 22:  
Bathrooms Collection

### FORMATS

- \*.max (Scanline)
- \*.max (MentalRay)
- \*.max (VRay)
- \*.c4d
- \*.c4d (VRay)
- \*.fbx
- \*.obj

### SPECIFICATION

Total size: 1.68 GB  
Materials: YES  
Textures: YES

### DESCRIPTION

CGAxis Models Volume 22 containing 70 highly detailed models of bathrooms appliances. Great for your project, compatible with 3ds max 2008 or higher and many others.

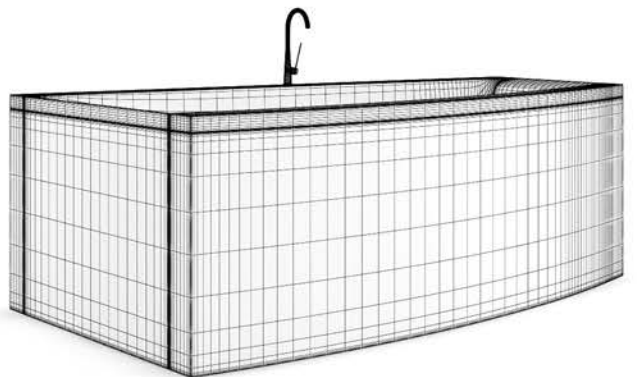

All models, textures, renders, materials, hdri etc. which can be purchased/downloaded from [www.cgaxis.com](http://www.cgaxis.com) are on Royalty-Free non-exclusive license. License is personal and NON transferable. Models, textures, renders, materials, hdri etc. that You have purchased are non-exclusively licensed, NOT sold to You. You can use CGAxis products as a part of a game, if the products are contained inside a propriety format and displays inside the game during play. In this case, you have to add in the producer's section the information that "models by CGAXIS.com". You can sell/resell rendered moving or still images, resold as a part of a feature film, movie advertisement etc. You have a possibility to publish renders in a book, on a poster, t-shirt, magazine, cover or any other item. You have the right to use your renders in every way - charge a fee for them, modify them, to make postproduction etc.

# BATHROOMS

## collection

VOLUME 22

038

### NAME

CGAxis Models Volume 22:  
Bathrooms Collection

### FORMATS

- \*.max (Scanline)
- \*.max (MentalRay)
- \*.max (VRay)
- \*.c4d
- \*.c4d (VRay)
- \*.fbx
- \*.obj

### SPECIFICATION

Total size: 1.68 GB  
Materials: YES  
Textures: YES

### DESCRIPTION

CGAxis Models Volume 22 containing 70 highly detailed models of bathrooms appliances. Great for your project, compatible with 3ds max 2008 or higher and many others.



All models, textures, renders, materials, hdri etc. which can be purchased/downloaded from [www.cgaxis.com](http://www.cgaxis.com) are on Royalty-Free non-exclusive license. License is personal and NON transferable. Models, textures, renders, materials, hdri etc. that You have purchased are non-exclusively licensed, NOT sold to You. You can use CGAxis products as a part of a game, if the products are contained inside a propriety format and displays inside the game during play. In this case, you have to add in the producer's section the information that "models by CGAXIS.com". You can sell/resell rendered moving or still images, resold as a part of a feature film, movie advertisement etc. You have a possibility to publish renders in a book, on a poster, t-shirt, magazine, cover or any other item. You have the right to use your renders in every way - charge a fee for them, modify them, to make postproduction etc.

# BATHROOMS

## collection

VOLUME 22

039

### NAME

CGAxis Models Volume 22:  
Bathrooms Collection

### FORMATS

- \*.max (Scanline)
- \*.max (MentalRay)
- \*.max (VRay)
- \*.c4d
- \*.c4d (VRay)
- \*.fbx
- \*.obj

### SPECIFICATION

Total size: 1.68 GB  
Materials: YES  
Textures: YES

### DESCRIPTION

CGAxis Models Volume 22 containing 70 highly detailed models of bathrooms appliances. Great for your project, compatible with 3ds max 2008 or higher and many others.

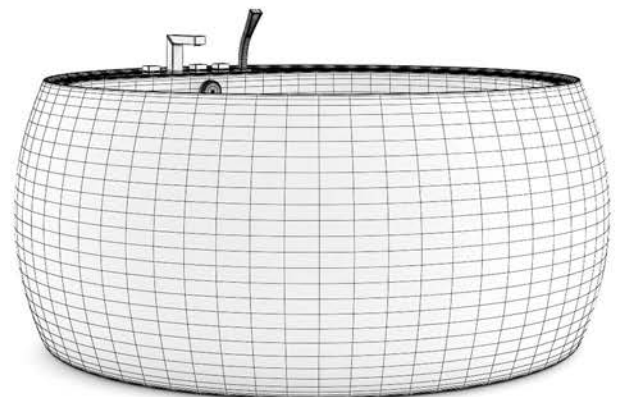

All models, textures, renders, materials, hdri etc. which can be purchased/downloaded from [www.cgaxis.com](http://www.cgaxis.com) are on Royalty-Free non-exclusive license. License is personal and NON transferable. Models, textures, renders, materials, hdri etc. that You have purchased are non-exclusively licensed, NOT sold to You. You can use CGAxis products as a part of a game, if the products are contained inside a propriety format and displays inside the game during play. In this case, you have to add in the producer's section the information that "models by CGAXIS.com". You can sell/resell rendered moving or still images, resold as a part of a feature film, movie advertisement etc. You have a possibility to publish renders in a book, on a poster, t-shirt, magazine, cover or any other item. You have the right to use your renders in every way - charge a fee for them, modify them, to make postproduction etc.

# BATHROOMS

## collection

VOLUME 22

040

### NAME

CGAxis Models Volume 22:  
Bathrooms Collection

### FORMATS

- \*.max (Scanline)
- \*.max (MentalRay)
- \*.max (VRay)
- \*.c4d
- \*.c4d (VRay)
- \*.fbx
- \*.obj

### SPECIFICATION

Total size: 1.68 GB  
Materials: YES  
Textures: YES

### DESCRIPTION

CGAxis Models Volume 22 containing 70 highly detailed models of bathrooms appliances. Great for your project, compatible with 3ds max 2008 or higher and many others.



All models, textures, renders, materials, hdri etc. which can be purchased/downloaded from [www.cgaxis.com](http://www.cgaxis.com) are on Royalty-Free non-exclusive license. License is personal and NON transferable. Models, textures, renders, materials, hdri etc. that You have purchased are non-exclusively licensed, NOT sold to You. You can use CGAxis products as a part of a game, if the products are contained inside a propriety format and displays inside the game during play. In this case, you have to add in the producer's section the information that "models by CGAXIS.com". You can sell/resell rendered moving or still images, resold as a part of a feature film, movie advertisement etc. You have a possibility to publish renders in a book, on a poster, t-shirt, magazine, cover or any other item. You have the right to use your renders in every way - charge a fee for them, modify them, to make postproduction etc.



# BATHROOMS

## collection

VOLUME 22

041

### NAME

CGAxis Models Volume 22:  
Bathrooms Collection

### FORMATS

- \*.max (Scanline)
- \*.max (MentalRay)
- \*.max (VRay)
- \*.c4d
- \*.c4d (VRay)
- \*.fbx
- \*.obj

### SPECIFICATION

Total size: 1.68 GB  
Materials: YES  
Textures: YES

### DESCRIPTION

CGAxis Models Volume 22 containing 70 highly detailed models of bathrooms appliances. Great for your project, compatible with 3ds max 2008 or higher and many others.



All models, textures, renders, materials, hdri etc. which can be purchased/downloaded from [www.cgaxis.com](http://www.cgaxis.com) are on Royalty-Free non-exclusive license. License is personal and NON transferable. Models, textures, renders, materials, hdri etc. that You have purchased are non-exclusively licensed, NOT sold to You. You can use CGAxis products as a part of a game, if the products are contained inside a propriety format and displays inside the game during play. In this case, you have to add in the producer's section the information that "models by CGAXIS.com". You can sell/resell rendered moving or still images, resold as a part of a feature film, movie advertisement etc. You have a possibility to publish renders in a book, on a poster, t-shirt, magazine, cover or any other item. You have the right to use your renders in every way - charge a fee for them, modify them, to make postproduction etc.

# BATHROOMS

## collection

VOLUME 22

042

### NAME

CGAxis Models Volume 22:  
Bathrooms Collection

### FORMATS

- \*.max (Scanline)
- \*.max (MentalRay)
- \*.max (VRay)
- \*.c4d
- \*.c4d (VRay)
- \*.fbx
- \*.obj

### SPECIFICATION

Total size: 1.68 GB  
Materials: YES  
Textures: YES

### DESCRIPTION

CGAxis Models Volume 22 containing 70 highly detailed models of bathrooms appliances. Great for your project, compatible with 3ds max 2008 or higher and many others.

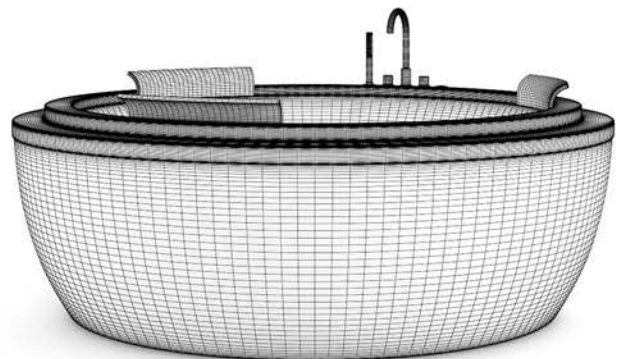

All models, textures, renders, materials, hdri etc. which can be purchased/downloaded from [www.cgaxis.com](http://www.cgaxis.com) are on Royalty-Free non-exclusive license. License is personal and NON transferable. Models, textures, renders, materials, hdri etc. that You have purchased are non-exclusively licensed, NOT sold to You. You can use CGAxis products as a part of a game, if the products are contained inside a propriety format and displays inside the game during play. In this case, you have to add in the producer's section the information that "models by CGAXIS.com". You can sell/resell rendered moving or still images, resold as a part of a feature film, movie advertisement etc. You have a possibility to publish renders in a book, on a poster, t-shirt, magazine, cover or any other item. You have the right to use your renders in every way - charge a fee for them, modify them, to make postproduction etc.

# BATHROOMS

## collection

VOLUME 22

043

### NAME

CGAxis Models Volume 22:  
Bathrooms Collection

### FORMATS

- \*.max (Scanline)
- \*.max (MentalRay)
- \*.max (VRay)
- \*.c4d
- \*.c4d (VRay)
- \*.fbx
- \*.obj

### SPECIFICATION

Total size: 1.68 GB  
Materials: YES  
Textures: YES

### DESCRIPTION

CGAxis Models Volume 22 containing 70 highly detailed models of bathrooms appliances. Great for your project, compatible with 3ds max 2008 or higher and many others.

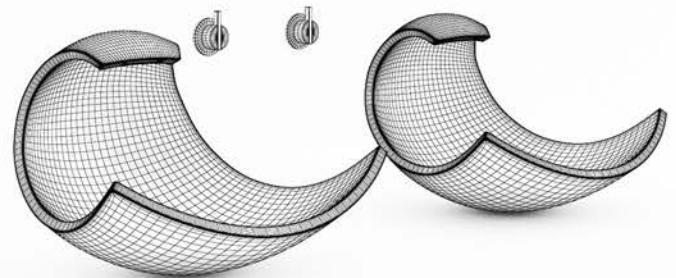

All models, textures, renders, materials, hdri etc. which can be purchased/downloaded from [www.cgaxis.com](http://www.cgaxis.com) are on Royalty-Free non-exclusive license. License is personal and NON transferable. Models, textures, renders, materials, hdri etc. that You have purchased are non-exclusively licensed, NOT sold to You. You can use CGAxis products as a part of a game, if the products are contained inside a propriety format and displays inside the game during play. In this case, you have to add in the producer's section the information that "models by CGAXIS.com". You can sell/resell rendered moving or still images, resold as a part of a feature film, movie advertisement etc. You have a possibility to publish renders in a book, on a poster, t-shirt, magazine, cover or any other item. You have the right to use your renders in every way - charge a fee for them, modify them, to make postproduction etc.

# BATHROOMS

## collection

VOLUME 22

044

### NAME

CGAxis Models Volume 22:  
Bathrooms Collection

### FORMATS

- \*.max (Scanline)
- \*.max (MentalRay)
- \*.max (VRay)
- \*.c4d
- \*.c4d (VRay)
- \*.fbx
- \*.obj

### SPECIFICATION

Total size: 1.68 GB  
Materials: YES  
Textures: YES

### DESCRIPTION

CGAxis Models Volume 22 containing 70 highly detailed models of bathrooms appliances. Great for your project, compatible with 3ds max 2008 or higher and many others.

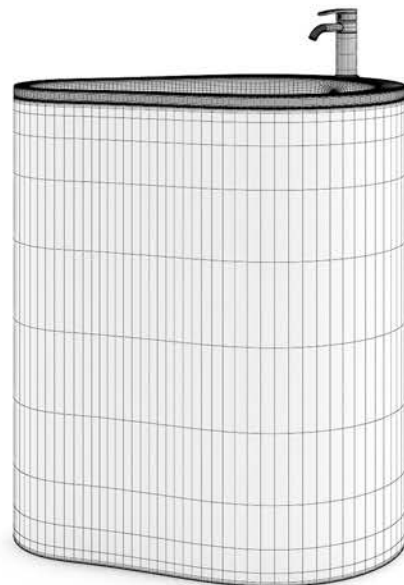

All models, textures, renders, materials, hdri etc. which can be purchased/downloaded from [www.cgaxis.com](http://www.cgaxis.com) are on Royalty-Free non-exclusive license. License is personal and NON transferable. Models, textures, renders, materials, hdri etc. that You have purchased are non-exclusively licensed, NOT sold to You. You can use CGAxis products as a part of a game, if the products are contained inside a propriety format and displays inside the game during play. In this case, you have to add in the producer's section the information that "models by CGAXIS.com". You can sell/resell rendered moving or still images, resold as a part of a feature film, movie advertisement etc. You have a possibility to publish renders in a book, on a poster, t-shirt, magazine, cover or any other item. You have the right to use your renders in every way - charge a fee for them, modify them, to make postproduction etc.

# BATHROOMS

## collection

VOLUME 22

045

### NAME

CGAxis Models Volume 22:  
Bathrooms Collection

### FORMATS

- \*.max (Scanline)
- \*.max (MentalRay)
- \*.max (VRay)
- \*.c4d
- \*.c4d (VRay)
- \*.fbx
- \*.obj

### SPECIFICATION

Total size: 1.68 GB  
Materials: YES  
Textures: YES

### DESCRIPTION

CGAxis Models Volume 22 containing 70 highly detailed models of bathrooms appliances. Great for your project, compatible with 3ds max 2008 or higher and many others.



All models, textures, renders, materials, hdri etc. which can be purchased/downloaded from [www.cgaxis.com](http://www.cgaxis.com) are on Royalty-Free non-exclusive license. License is personal and NON transferable. Models, textures, renders, materials, hdri etc. that You have purchased are non-exclusively licensed, NOT sold to You. You can use CGAxis products as a part of a game, if the products are contained inside a propriety format and displays inside the game during play. In this case, you have to add in the producer's section the information that "models by CGAXIS.com". You can sell/resell rendered moving or still images, resold as a part of a feature film, movie advertisement etc. You have a possibility to publish renders in a book, on a poster, t-shirt, magazine, cover or any other item. You have the right to use your renders in every way - charge a fee for them, modify them, to make postproduction etc.

# BATHROOMS

## collection

VOLUME 22

046

### NAME

CGAxis Models Volume 22:  
Bathrooms Collection

### FORMATS

- \*.max (Scanline)
- \*.max (MentalRay)
- \*.max (VRay)
- \*.c4d
- \*.c4d (VRay)
- \*.fbx
- \*.obj

### SPECIFICATION

Total size: 1.68 GB  
Materials: YES  
Textures: YES

### DESCRIPTION

CGAxis Models Volume 22 containing 70 highly detailed models of bathrooms appliances. Great for your project, compatible with 3ds max 2008 or higher and many others.



All models, textures, renders, materials, hdri etc. which can be purchased/downloaded from [www.cgaxis.com](http://www.cgaxis.com) are on Royalty-Free non-exclusive license. License is personal and NON transferable. Models, textures, renders, materials, hdri etc. that You have purchased are non-exclusively licensed, NOT sold to You. You can use CGAxis products as a part of a game, if the products are contained inside a propriety format and displays inside the game during play. In this case, you have to add in the producer's section the information that "models by CGAXIS.com". You can sell/resell rendered moving or still images, resold as a part of a feature film, movie advertisement etc. You have a possibility to publish renders in a book, on a poster, t-shirt, magazine, cover or any other item. You have the right to use your renders in every way - charge a fee for them, modify them, to make postproduction etc.



# BATHROOMS

## collection

VOLUME 22

047

### NAME

CGAxis Models Volume 22:  
Bathrooms Collection

### FORMATS

- \*.max (Scanline)
- \*.max (MentalRay)
- \*.max (VRay)
- \*.c4d
- \*.c4d (VRay)
- \*.fbx
- \*.obj

### SPECIFICATION

Total size: 1.68 GB  
Materials: YES  
Textures: YES

### DESCRIPTION

CGAxis Models Volume 22 containing 70 highly detailed models of bathrooms appliances. Great for your project, compatible with 3ds max 2008 or higher and many others.



All models, textures, renders, materials, hdri etc. which can be purchased/downloaded from [www.cgaxis.com](http://www.cgaxis.com) are on Royalty-Free non-exclusive license. License is personal and NON transferable. Models, textures, renders, materials, hdri etc. that You have purchased are non-exclusively licensed, NOT sold to You. You can use CGAxis products as a part of a game, if the products are contained inside a propriety format and displays inside the game during play. In this case, you have to add in the producer's section the information that "models by CGAXIS.com". You can sell/resell rendered moving or still images, resold as a part of a feature film, movie advertisement etc. You have a possibility to publish renders in a book, on a poster, t-shirt, magazine, cover or any other item. You have the right to use your renders in every way - charge a fee for them, modify them, to make postproduction etc.

# BATHROOMS

## collection

VOLUME 22

048

### NAME

CGAxis Models Volume 22:  
Bathrooms Collection

### FORMATS

- \*.max (Scanline)
- \*.max (MentalRay)
- \*.max (VRay)
- \*.c4d
- \*.c4d (VRay)
- \*.fbx
- \*.obj

### SPECIFICATION

Total size: 1.68 GB  
Materials: YES  
Textures: YES

### DESCRIPTION

CGAxis Models Volume 22 containing 70 highly detailed models of bathrooms appliances. Great for your project, compatible with 3ds max 2008 or higher and many others.



All models, textures, renders, materials, hdri etc. which can be purchased/downloaded from [www.cgaxis.com](http://www.cgaxis.com) are on Royalty-Free non-exclusive license. License is personal and NON transferable. Models, textures, renders, materials, hdri etc. that You have purchased are non-exclusively licensed, NOT sold to You. You can use CGAxis products as a part of a game, if the products are contained inside a propriety format and displays inside the game during play. In this case, you have to add in the producer's section the information that "models by CGAXIS.com". You can sell/resell rendered moving or still images, resold as a part of a feature film, movie advertisement etc. You have a possibility to publish renders in a book, on a poster, t-shirt, magazine, cover or any other item. You have the right to use your renders in every way - charge a fee for them, modify them, to make postproduction etc.

# BATHROOMS

## collection

VOLUME 22

049

### NAME

CGAxis Models Volume 22:  
Bathrooms Collection

### FORMATS

- \*.max (Scanline)
- \*.max (MentalRay)
- \*.max (VRay)
- \*.c4d
- \*.c4d (VRay)
- \*.fbx
- \*.obj

### SPECIFICATION

Total size: 1.68 GB  
Materials: YES  
Textures: YES

### DESCRIPTION

CGAxis Models Volume 22 containing 70 highly detailed models of bathrooms appliances. Great for your project, compatible with 3ds max 2008 or higher and many others.

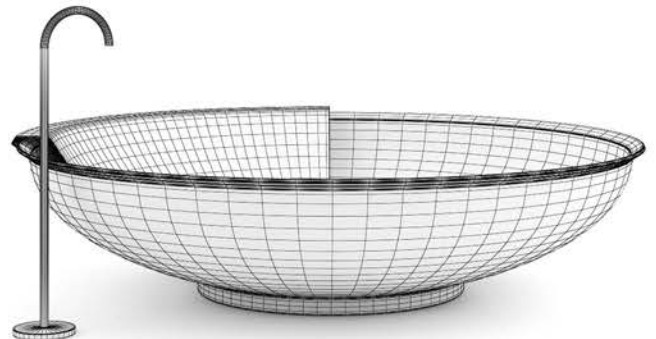

All models, textures, renders, materials, hdri etc. which can be purchased/downloaded from [www.cgaxis.com](http://www.cgaxis.com) are on Royalty-Free non-exclusive license. License is personal and NON transferable. Models, textures, renders, materials, hdri etc. that You have purchased are non-exclusively licensed, NOT sold to You. You can use CGAxis products as a part of a game, if the products are contained inside a propriety format and displays inside the game during play. In this case, you have to add in the producer's section the information that "models by CGAXIS.com". You can sell/resell rendered moving or still images, resold as a part of a feature film, movie advertisement etc. You have a possibility to publish renders in a book, on a poster, t-shirt, magazine, cover or any other item. You have the right to use your renders in every way - charge a fee for them, modify them, to make postproduction etc.

# BATHROOMS

## collection

VOLUME 22

050

### NAME

CGAxis Models Volume 22:  
Bathrooms Collection

### FORMATS

- \*.max (Scanline)
- \*.max (MentalRay)
- \*.max (VRay)
- \*.c4d
- \*.c4d (VRay)
- \*.fbx
- \*.obj

### SPECIFICATION

Total size: 1.68 GB  
Materials: YES  
Textures: YES

### DESCRIPTION

CGAxis Models Volume 22 containing 70 highly detailed models of bathrooms appliances. Great for your project, compatible with 3ds max 2008 or higher and many others.

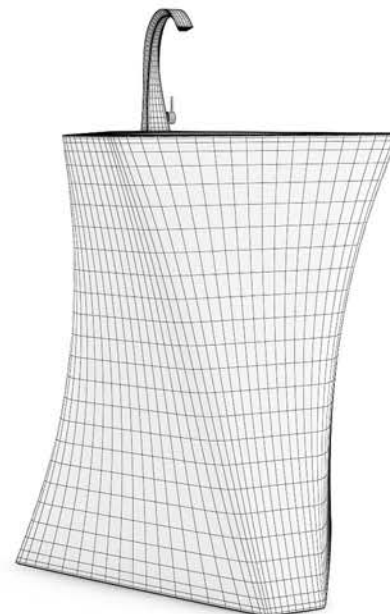

All models, textures, renders, materials, hdri etc. which can be purchased/downloaded from [www.cgaxis.com](http://www.cgaxis.com) are on Royalty-Free non-exclusive license. License is personal and NON transferable. Models, textures, renders, materials, hdri etc. that You have purchased are non-exclusively licensed, NOT sold to You. You can use CGAxis products as a part of a game, if the products are contained inside a propriety format and displays inside the game during play. In this case, you have to add in the producer's section the information that "models by CGAXIS.com". You can sell/resell rendered moving or still images, resold as a part of a feature film, movie advertisement etc. You have a possibility to publish renders in a book, on a poster, t-shirt, magazine, cover or any other item. You have the right to use your renders in every way - charge a fee for them, modify them, to make postproduction etc.

# BATHROOMS

## collection

VOLUME 22

051

### NAME

CGAxis Models Volume 22:  
Bathrooms Collection

### FORMATS

- \*.max (Scanline)
- \*.max (MentalRay)
- \*.max (VRay)
- \*.c4d
- \*.c4d (VRay)
- \*.fbx
- \*.obj

### SPECIFICATION

Total size: 1.68 GB  
Materials: YES  
Textures: YES

### DESCRIPTION

CGAxis Models Volume 22 containing 70 highly detailed models of bathrooms appliances. Great for your project, compatible with 3ds max 2008 or higher and many others.



All models, textures, renders, materials, hdri etc. which can be purchased/downloaded from [www.cgaxis.com](http://www.cgaxis.com) are on Royalty-Free non-exclusive license. License is personal and NON transferable. Models, textures, renders, materials, hdri etc. that You have purchased are non-exclusively licensed, NOT sold to You. You can use CGAxis products as a part of a game, if the products are contained inside a propriety format and displays inside the game during play. In this case, you have to add in the producer's section the information that "models by CGAXIS.com". You can sell/resell rendered moving or still images, resold as a part of a feature film, movie advertisement etc. You have a possibility to publish renders in a book, on a poster, t-shirt, magazine, cover or any other item. You have the right to use your renders in every way - charge a fee for them, modify them, to make postproduction etc.

# BATHROOMS

## collection

VOLUME 22

052

### NAME

CGAxis Models Volume 22:  
Bathrooms Collection

### FORMATS

- \*.max (Scanline)
- \*.max (MentalRay)
- \*.max (VRay)
- \*.c4d
- \*.c4d (VRay)
- \*.fbx
- \*.obj

### SPECIFICATION

Total size: 1.68 GB  
Materials: YES  
Textures: YES

### DESCRIPTION

CGAxis Models Volume 22 containing 70 highly detailed models of bathrooms appliances. Great for your project, compatible with 3ds max 2008 or higher and many others.

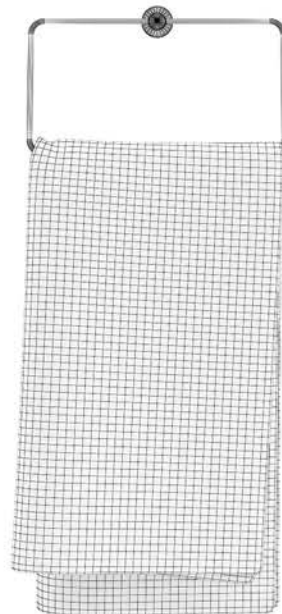

All models, textures, renders, materials, hdri etc. which can be purchased/downloaded from [www.cgaxis.com](http://www.cgaxis.com) are on Royalty-Free non-exclusive license. License is personal and NON transferable. Models, textures, renders, materials, hdri etc. that You have purchased are non-exclusively licensed, NOT sold to You. You can use CGAxis products as a part of a game, if the products are contained inside a propriety format and displays inside the game during play. In this case, you have to add in the producer's section the information that "models by CGAXIS.com". You can sell/resell rendered moving or still images, resold as a part of a feature film, movie advertisement etc. You have a possibility to publish renders in a book, on a poster, t-shirt, magazine, cover or any other item. You have the right to use your renders in every way - charge a fee for them, modify them, to make postproduction etc.



# BATHROOMS

## collection

VOLUME 22

053

### NAME

CGAxis Models Volume 22:  
Bathrooms Collection

### FORMATS

- \*.max (Scanline)
- \*.max (MentalRay)
- \*.max (VRay)
- \*.c4d
- \*.c4d (VRay)
- \*.fbx
- \*.obj

### SPECIFICATION

Total size: 1.68 GB  
Materials: YES  
Textures: YES

### DESCRIPTION

CGAxis Models Volume 22 containing 70 highly detailed models of bathrooms appliances. Great for your project, compatible with 3ds max 2008 or higher and many others.

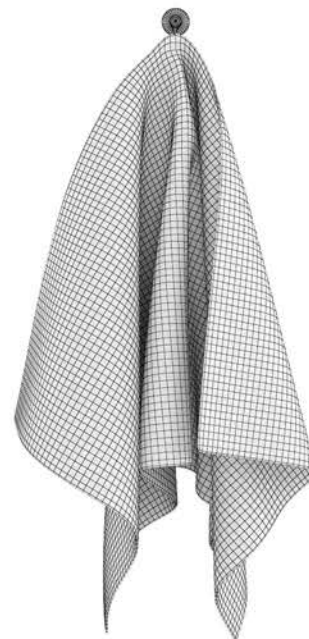

All models, textures, renders, materials, hdri etc. which can be purchased/downloaded from [www.cgaxis.com](http://www.cgaxis.com) are on Royalty-Free non-exclusive license. License is personal and NON transferable. Models, textures, renders, materials, hdri etc. that You have purchased are non-exclusively licensed, NOT sold to You. You can use CGAxis products as a part of a game, if the products are contained inside a propriety format and displays inside the game during play. In this case, you have to add in the producer's section the information that "models by CGAXIS.com". You can sell/resell rendered moving or still images, resold as a part of a feature film, movie advertisement etc. You have a possibility to publish renders in a book, on a poster, t-shirt, magazine, cover or any other item. You have the right to use your renders in every way - charge a fee for them, modify them, to make postproduction etc.

# BATHROOMS

## collection

VOLUME 22

054

### NAME

CGAxis Models Volume 22:  
Bathrooms Collection

### FORMATS

\*.max (Scanline)  
\*.max (MentalRay)  
\*.max (VRay)  
\*.c4d  
\*.c4d (VRay)  
\*.fbx  
\*.obj

### SPECIFICATION

Total size: 1.68 GB  
Materials: YES  
Textures: YES

### DESCRIPTION

CGAxis Models Volume 22 containing 70 highly detailed models of bathrooms appliances. Great for your project, compatible with 3ds max 2008 or higher and many others.



All models, textures, renders, materials, hdri etc. which can be purchased/downloaded from [www.cgaxis.com](http://www.cgaxis.com) are on Royalty-Free non-exclusive license. License is personal and NON transferable. Models, textures, renders, materials, hdri etc. that You have purchased are non-exclusively licensed, NOT sold to You. You can use CGAxis products as a part of a game, if the products are contained inside a propriety format and displays inside the game during play. In this case, you have to add in the producer's section the information that "models by CGAXIS.com". You can sell/resell rendered moving or still images, resold as a part of a feature film, movie advertisement etc. You have a possibility to publish renders in a book, on a poster, t-shirt, magazine, cover or any other item. You have the right to use your renders in every way - charge a fee for them, modify them, to make postproduction etc.

# BATHROOMS

## collection

VOLUME 22

055

### NAME

CGAxis Models Volume 22:  
Bathrooms Collection

### FORMATS

\*.max (Scanline)  
\*.max (MentalRay)  
\*.max (VRay)  
\*.c4d  
\*.c4d (VRay)  
\*.fbx  
\*.obj

### SPECIFICATION

Total size: 1.68 GB  
Materials: YES  
Textures: YES

### DESCRIPTION

CGAxis Models Volume 22 containing 70 highly detailed models of bathrooms appliances. Great for your project, compatible with 3ds max 2008 or higher and many others.

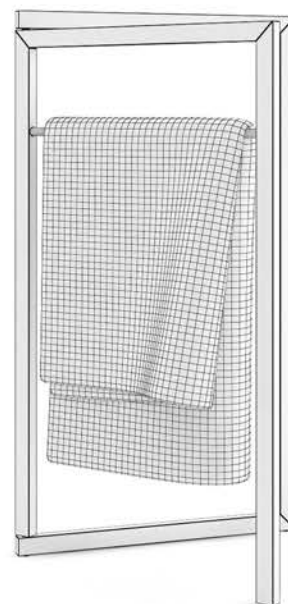
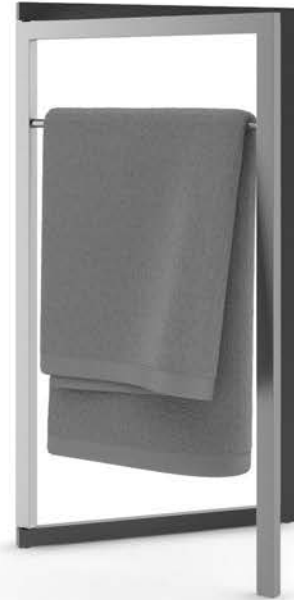

All models, textures, renders, materials, hdri etc. which can be purchased/downloaded from [www.cgaxis.com](http://www.cgaxis.com) are on Royalty-Free non-exclusive license. License is personal and NON transferable. Models, textures, renders, materials, hdri etc. that You have purchased are non-exclusively licensed, NOT sold to You. You can use CGAxis products as a part of a game, if the products are contained inside a propriety format and displays inside the game during play. In this case, you have to add in the producer's section the information that "models by CGAXIS.com". You can sell/resell rendered moving or still images, resold as a part of a feature film, movie advertisement etc. You have a possibility to publish renders in a book, on a poster, t-shirt, magazine, cover or any other item. You have the right to use your renders in every way - charge a fee for them, modify them, to make postproduction etc.

# BATHROOMS

## collection

VOLUME 22

056

### NAME

CGAxis Models Volume 22:  
Bathrooms Collection

### FORMATS

- \*.max (Scanline)
- \*.max (MentalRay)
- \*.max (VRay)
- \*.c4d
- \*.c4d (VRay)
- \*.fbx
- \*.obj

### SPECIFICATION

Total size: 1.68 GB  
Materials: YES  
Textures: YES

### DESCRIPTION

CGAxis Models Volume 22 containing 70 highly detailed models of bathrooms appliances. Great for your project, compatible with 3ds max 2008 or higher and many others.



All models, textures, renders, materials, hdri etc. which can be purchased/downloaded from [www.cgaxis.com](http://www.cgaxis.com) are on Royalty-Free non-exclusive license. License is personal and NON transferable. Models, textures, renders, materials, hdri etc. that You have purchased are non-exclusively licensed, NOT sold to You. You can use CGAxis products as a part of a game, if the products are contained inside a propriety format and displays inside the game during play. In this case, you have to add in the producer's section the information that "models by CGAXIS.com". You can sell/resell rendered moving or still images, resold as a part of a feature film, movie advertisement etc. You have a possibility to publish renders in a book, on a poster, t-shirt, magazine, cover or any other item. You have the right to use your renders in every way - charge a fee for them, modify them, to make postproduction etc.

# BATHROOMS

## collection

VOLUME 22

057

### NAME

CGAxis Models Volume 22:  
Bathrooms Collection

### FORMATS

- \*.max (Scanline)
- \*.max (MentalRay)
- \*.max (VRay)
- \*.c4d
- \*.c4d (VRay)
- \*.fbx
- \*.obj

### SPECIFICATION

Total size: 1.68 GB  
Materials: YES  
Textures: YES

### DESCRIPTION

CGAxis Models Volume 22 containing 70 highly detailed models of bathrooms appliances. Great for your project, compatible with 3ds max 2008 or higher and many others.

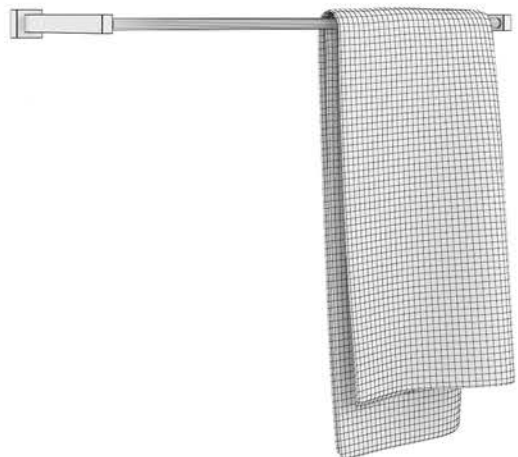

All models, textures, renders, materials, hdri etc. which can be purchased/downloaded from [www.cgaxis.com](http://www.cgaxis.com) are on Royalty-Free non-exclusive license. License is personal and NON transferable. Models, textures, renders, materials, hdri etc. that You have purchased are non-exclusively licensed, NOT sold to You. You can use CGAxis products as a part of a game, if the products are contained inside a propriety format and displays inside the game during play. In this case, you have to add in the producer's section the information that "models by CGAXIS.com". You can sell/resell rendered moving or still images, resold as a part of a feature film, movie advertisement etc. You have a possibility to publish renders in a book, on a poster, t-shirt, magazine, cover or any other item. You have the right to use your renders in every way - charge a fee for them, modify them, to make postproduction etc.

# BATHROOMS

## collection

VOLUME 22

058

### NAME

CGAxis Models Volume 22:  
Bathrooms Collection

### FORMATS

- \*.max (Scanline)
- \*.max (MentalRay)
- \*.max (VRay)
- \*.c4d
- \*.c4d (VRay)
- \*.fbx
- \*.obj

### SPECIFICATION

Total size: 1.68 GB  
Materials: YES  
Textures: YES

### DESCRIPTION

CGAxis Models Volume 22 containing 70 highly detailed models of bathrooms appliances. Great for your project, compatible with 3ds max 2008 or higher and many others.



All models, textures, renders, materials, hdri etc. which can be purchased/downloaded from [www.cgaxis.com](http://www.cgaxis.com) are on Royalty-Free non-exclusive license. License is personal and NON transferable. Models, textures, renders, materials, hdri etc. that You have purchased are non-exclusively licensed, NOT sold to You. You can use CGAxis products as a part of a game, if the products are contained inside a propriety format and displays inside the game during play. In this case, you have to add in the producer's section the information that "models by CGAXIS.com". You can sell/resell rendered moving or still images, resold as a part of a feature film, movie advertisement etc. You have a possibility to publish renders in a book, on a poster, t-shirt, magazine, cover or any other item. You have the right to use your renders in every way - charge a fee for them, modify them, to make postproduction etc.



# BATHROOMS

## collection

VOLUME 22

059

### NAME

CGAxis Models Volume 22:  
Bathrooms Collection

### FORMATS

- \*.max (Scanline)
- \*.max (MentalRay)
- \*.max (VRay)
- \*.c4d
- \*.c4d (VRay)
- \*.fbx
- \*.obj

### SPECIFICATION

Total size: 1.68 GB  
Materials: YES  
Textures: YES

### DESCRIPTION

CGAxis Models Volume 22 containing 70 highly detailed models of bathrooms appliances. Great for your project, compatible with 3ds max 2008 or higher and many others.

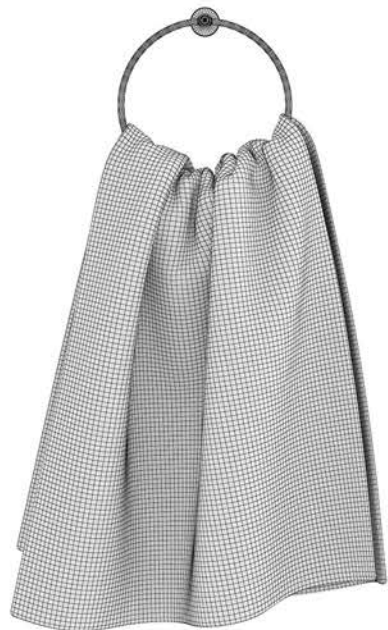

All models, textures, renders, materials, hdri etc. which can be purchased/downloaded from [www.cgaxis.com](http://www.cgaxis.com) are on Royalty-Free non-exclusive license. License is personal and NON transferable. Models, textures, renders, materials, hdri etc. that You have purchased are non-exclusively licensed, NOT sold to You. You can use CGAxis products as a part of a game, if the products are contained inside a propriety format and displays inside the game during play. In this case, you have to add in the producer's section the information that "models by CGAXIS.com". You can sell/resell rendered moving or still images, resold as a part of a feature film, movie advertisement etc. You have a possibility to publish renders in a book, on a poster, t-shirt, magazine, cover or any other item. You have the right to use your renders in every way - charge a fee for them, modify them, to make postproduction etc.



# BATHROOMS

## collection

VOLUME 22

060

### NAME

CGAxis Models Volume 22:  
Bathrooms Collection

### FORMATS

\*.max (Scanline)  
\*.max (MentalRay)  
\*.max (VRay)  
\*.c4d  
\*.c4d (VRay)  
\*.fbx  
\*.obj

### SPECIFICATION

Total size: 1.68 GB  
Materials: YES  
Textures: YES

### DESCRIPTION

CGAxis Models Volume 22 containing 70 highly detailed models of bathrooms appliances. Great for your project, compatible with 3ds max 2008 or higher and many others.

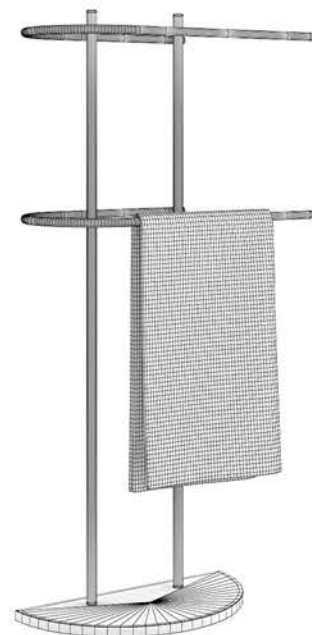

All models, textures, renders, materials, hdri etc. which can be purchased/downloaded from [www.cgaxis.com](http://www.cgaxis.com) are on Royalty-Free non-exclusive license. License is personal and NON transferable. Models, textures, renders, materials, hdri etc. that You have purchased are non-exclusively licensed, NOT sold to You. You can use CGAxis products as a part of a game, if the products are contained inside a propriety format and displays inside the game during play. In this case, you have to add in the producer's section the information that "models by CGAXIS.com". You can sell/resell rendered moving or still images, resold as a part of a feature film, movie advertisement etc. You have a possibility to publish renders in a book, on a poster, t-shirt, magazine, cover or any other item. You have the right to use your renders in every way - charge a fee for them, modify them, to make postproduction etc.

# BATHROOMS

## collection

VOLUME 22

061

### NAME

CGAxis Models Volume 22:  
Bathrooms Collection

### FORMATS

- \*.max (Scanline)
- \*.max (MentalRay)
- \*.max (VRay)
- \*.c4d
- \*.c4d (VRay)
- \*.fbx
- \*.obj

### SPECIFICATION

Total size: 1.68 GB  
Materials: YES  
Textures: YES

### DESCRIPTION

CGAxis Models Volume 22 containing 70 highly detailed models of bathrooms appliances. Great for your project, compatible with 3ds max 2008 or higher and many others.



All models, textures, renders, materials, hdri etc. which can be purchased/downloaded from [www.cgaxis.com](http://www.cgaxis.com) are on Royalty-Free non-exclusive license. License is personal and NON transferable. Models, textures, renders, materials, hdri etc. that You have purchased are non-exclusively licensed, NOT sold to You. You can use CGAxis products as a part of a game, if the products are contained inside a propriety format and displays inside the game during play. In this case, you have to add in the producer's section the information that "models by CGAXIS.com". You can sell/resell rendered moving or still images, resold as a part of a feature film, movie advertisement etc. You have a possibility to publish renders in a book, on a poster, t-shirt, magazine, cover or any other item. You have the right to use your renders in every way - charge a fee for them, modify them, to make postproduction etc.

# BATHROOMS

## collection

VOLUME 22

062

### NAME

CGAxis Models Volume 22:  
Bathrooms Collection

### FORMATS

- \*.max (Scanline)
- \*.max (MentalRay)
- \*.max (VRay)
- \*.c4d
- \*.c4d (VRay)
- \*.fbx
- \*.obj

### SPECIFICATION

Total size: 1.68 GB  
Materials: YES  
Textures: YES

### DESCRIPTION

CGAxis Models Volume 22 containing 70 highly detailed models of bathrooms appliances. Great for your project, compatible with 3ds max 2008 or higher and many others.



All models, textures, renders, materials, hdri etc. which can be purchased/downloaded from [www.cgaxis.com](http://www.cgaxis.com) are on Royalty-Free non-exclusive license. License is personal and NON transferable. Models, textures, renders, materials, hdri etc. that You have purchased are non-exclusively licensed, NOT sold to You. You can use CGAxis products as a part of a game, if the products are contained inside a propriety format and displays inside the game during play. In this case, you have to add in the producer's section the information that "models by CGAXIS.com". You can sell/resell rendered moving or still images, resold as a part of a feature film, movie advertisement etc. You have a possibility to publish renders in a book, on a poster, t-shirt, magazine, cover or any other item. You have the right to use your renders in every way - charge a fee for them, modify them, to make postproduction etc.

# BATHROOMS

## collection

VOLUME 22

063

### NAME

CGAxis Models Volume 22:  
Bathrooms Collection

### FORMATS

- \*.max (Scanline)
- \*.max (MentalRay)
- \*.max (VRay)
- \*.c4d
- \*.c4d (VRay)
- \*.fbx
- \*.obj

### SPECIFICATION

Total size: 1.68 GB  
Materials: YES  
Textures: YES

### DESCRIPTION

CGAxis Models Volume 22 containing 70 highly detailed models of bathrooms appliances. Great for your project, compatible with 3ds max 2008 or higher and many others.



All models, textures, renders, materials, hdri etc. which can be purchased/downloaded from [www.cgaxis.com](http://www.cgaxis.com) are on Royalty-Free non-exclusive license. License is personal and NON transferable. Models, textures, renders, materials, hdri etc. that You have purchased are non-exclusively licensed, NOT sold to You. You can use CGAxis products as a part of a game, if the products are contained inside a propriety format and displays inside the game during play. In this case, you have to add in the producer's section the information that "models by CGAXIS.com". You can sell/resell rendered moving or still images, resold as a part of a feature film, movie advertisement etc. You have a possibility to publish renders in a book, on a poster, t-shirt, magazine, cover or any other item. You have the right to use your renders in every way - charge a fee for them, modify them, to make postproduction etc.

# BATHROOMS

## collection

VOLUME 22

064

### NAME

CGAxis Models Volume 22:  
Bathrooms Collection

### FORMATS

- \*.max (Scanline)
- \*.max (MentalRay)
- \*.max (VRay)
- \*.c4d
- \*.c4d (VRay)
- \*.fbx
- \*.obj

### SPECIFICATION

Total size: 1.68 GB  
Materials: YES  
Textures: YES

### DESCRIPTION

CGAxis Models Volume 22 containing 70 highly detailed models of bathrooms appliances. Great for your project, compatible with 3ds max 2008 or higher and many others.



All models, textures, renders, materials, hdri etc. which can be purchased/downloaded from [www.cgaxis.com](http://www.cgaxis.com) are on Royalty-Free non-exclusive license. License is personal and NON transferable. Models, textures, renders, materials, hdri etc. that You have purchased are non-exclusively licensed, NOT sold to You. You can use CGAxis products as a part of a game, if the products are contained inside a propriety format and displays inside the game during play. In this case, you have to add in the producer's section the information that "models by CGAXIS.com". You can sell/resell rendered moving or still images, resold as a part of a feature film, movie advertisement etc. You have a possibility to publish renders in a book, on a poster, t-shirt, magazine, cover or any other item. You have the right to use your renders in every way - charge a fee for them, modify them, to make postproduction etc.

# BATHROOMS

## collection

VOLUME 22

065

### NAME

CGAxis Models Volume 22:  
Bathrooms Collection

### FORMATS

- \*.max (Scanline)
- \*.max (MentalRay)
- \*.max (VRay)
- \*.c4d
- \*.c4d (VRay)
- \*.fbx
- \*.obj

### SPECIFICATION

Total size: 1.68 GB  
Materials: YES  
Textures: YES

### DESCRIPTION

CGAxis Models Volume 22 containing 70 highly detailed models of bathrooms appliances. Great for your project, compatible with 3ds max 2008 or higher and many others.



All models, textures, renders, materials, hdri etc. which can be purchased/downloaded from [www.cgaxis.com](http://www.cgaxis.com) are on Royalty-Free non-exclusive license. License is personal and NON transferable. Models, textures, renders, materials, hdri etc. that You have purchased are non-exclusively licensed, NOT sold to You. You can use CGAxis products as a part of a game, if the products are contained inside a propriety format and displays inside the game during play. In this case, you have to add in the producer's section the information that "models by CGAXIS.com". You can sell/resell rendered moving or still images, resold as a part of a feature film, movie advertisement etc. You have a possibility to publish renders in a book, on a poster, t-shirt, magazine, cover or any other item. You have the right to use your renders in every way - charge a fee for them, modify them, to make postproduction etc.



# BATHROOMS

## collection

VOLUME 22

066

### NAME

CGAxis Models Volume 22:  
Bathrooms Collection

### FORMATS

- \*.max (Scanline)
- \*.max (MentalRay)
- \*.max (VRay)
- \*.c4d
- \*.c4d (VRay)
- \*.fbx
- \*.obj

### SPECIFICATION

Total size: 1.68 GB  
Materials: YES  
Textures: YES

### DESCRIPTION

CGAxis Models Volume 22 containing 70 highly detailed models of bathrooms appliances. Great for your project, compatible with 3ds max 2008 or higher and many others.



All models, textures, renders, materials, hdri etc. which can be purchased/downloaded from [www.cgaxis.com](http://www.cgaxis.com) are on Royalty-Free non-exclusive license. License is personal and NON transferable. Models, textures, renders, materials, hdri etc. that You have purchased are non-exclusively licensed, NOT sold to You. You can use CGAxis products as a part of a game, if the products are contained inside a propriety format and displays inside the game during play. In this case, you have to add in the producer's section the information that "models by CGAXIS.com". You can sell/resell rendered moving or still images, resold as a part of a feature film, movie advertisement etc. You have a possibility to publish renders in a book, on a poster, t-shirt, magazine, cover or any other item. You have the right to use your renders in every way - charge a fee for them, modify them, to make postproduction etc.



# BATHROOMS

## collection

VOLUME 22

067

### NAME

CGAxis Models Volume 22:  
Bathrooms Collection

### FORMATS

- \*.max (Scanline)
- \*.max (MentalRay)
- \*.max (VRay)
- \*.c4d
- \*.c4d (VRay)
- \*.fbx
- \*.obj

### SPECIFICATION

Total size: 1.68 GB  
Materials: YES  
Textures: YES

### DESCRIPTION

CGAxis Models Volume 22 containing 70 highly detailed models of bathrooms appliances. Great for your project, compatible with 3ds max 2008 or higher and many others.

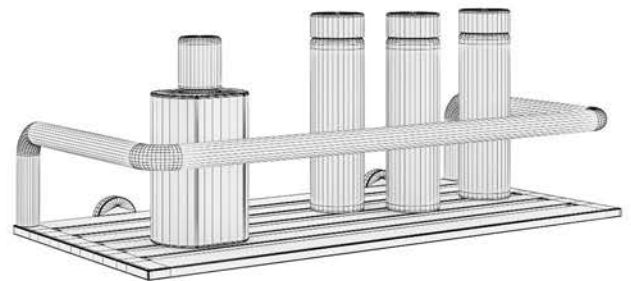

All models, textures, renders, materials, hdri etc. which can be purchased/downloaded from [www.cgaxis.com](http://www.cgaxis.com) are on Royalty-Free non-exclusive license. License is personal and NON transferable. Models, textures, renders, materials, hdri etc. that You have purchased are non-exclusively licensed, NOT sold to You. You can use CGAxis products as a part of a game, if the products are contained inside a propriety format and displays inside the game during play. In this case, you have to add in the producer's section the information that "models by CGAXIS.com". You can sell/resell rendered moving or still images, resold as a part of a feature film, movie advertisement etc. You have a possibility to publish renders in a book, on a poster, t-shirt, magazine, cover or any other item. You have the right to use your renders in every way - charge a fee for them, modify them, to make postproduction etc.

# BATHROOMS

## collection

VOLUME 22

068

### NAME

CGAxis Models Volume 22:  
Bathrooms Collection

### FORMATS

- \*.max (Scanline)
- \*.max (MentalRay)
- \*.max (VRay)
- \*.c4d
- \*.c4d (VRay)
- \*.fbx
- \*.obj

### SPECIFICATION

Total size: 1.68 GB  
Materials: YES  
Textures: YES

### DESCRIPTION

CGAxis Models Volume 22 containing 70 highly detailed models of bathrooms appliances. Great for your project, compatible with 3ds max 2008 or higher and many others.

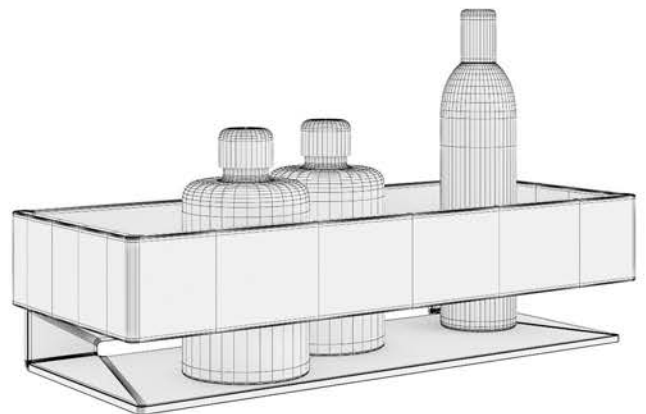

All models, textures, renders, materials, hdri etc. which can be purchased/downloaded from [www.cgaxis.com](http://www.cgaxis.com) are on Royalty-Free non-exclusive license. License is personal and NON transferable. Models, textures, renders, materials, hdri etc. that You have purchased are non-exclusively licensed, NOT sold to You. You can use CGAxis products as a part of a game, if the products are contained inside a propriety format and displays inside the game during play. In this case, you have to add in the producer's section the information that "models by CGAXIS.com". You can sell/resell rendered moving or still images, resold as a part of a feature film, movie advertisement etc. You have a possibility to publish renders in a book, on a poster, t-shirt, magazine, cover or any other item. You have the right to use your renders in every way - charge a fee for them, modify them, to make postproduction etc.

# BATHROOMS

## collection

VOLUME 22

069

### NAME

CGAxis Models Volume 22:  
Bathrooms Collection

### FORMATS

- \*.max (Scanline)
- \*.max (MentalRay)
- \*.max (VRay)
- \*.c4d
- \*.c4d (VRay)
- \*.fbx
- \*.obj

### SPECIFICATION

Total size: 1.68 GB  
Materials: YES  
Textures: YES

### DESCRIPTION

CGAxis Models Volume 22 containing 70 highly detailed models of bathrooms appliances. Great for your project, compatible with 3ds max 2008 or higher and many others.



All models, textures, renders, materials, hdri etc. which can be purchased/downloaded from [www.cgaxis.com](http://www.cgaxis.com) are on Royalty-Free non-exclusive license. License is personal and NON transferable. Models, textures, renders, materials, hdri etc. that You have purchased are non-exclusively licensed, NOT sold to You. You can use CGAxis products as a part of a game, if the products are contained inside a propriety format and displays inside the game during play. In this case, you have to add in the producer's section the information that "models by CGAXIS.com". You can sell/resell rendered moving or still images, resold as a part of a feature film, movie advertisement etc. You have a possibility to publish renders in a book, on a poster, t-shirt, magazine, cover or any other item. You have the right to use your renders in every way - charge a fee for them, modify them, to make postproduction etc.

# BATHROOMS

## collection

VOLUME 22

070

### NAME

CGAxis Models Volume 22:  
Bathrooms Collection

### FORMATS

- \*.max (Scanline)
- \*.max (MentalRay)
- \*.max (VRay)
- \*.c4d
- \*.c4d (VRay)
- \*.fbx
- \*.obj

### SPECIFICATION

Total size: 1.68 GB  
Materials: YES  
Textures: YES

### DESCRIPTION

CGAxis Models Volume 22 containing 70 highly detailed models of bathrooms appliances. Great for your project, compatible with 3ds max 2008 or higher and many others.



All models, textures, renders, materials, hdri etc. which can be purchased/downloaded from [www.cgaxis.com](http://www.cgaxis.com) are on Royalty-Free non-exclusive license. License is personal and NON transferable. Models, textures, renders, materials, hdri etc. that You have purchased are non-exclusively licensed, NOT sold to You. You can use CGAxis products as a part of a game, if the products are contained inside a propriety format and displays inside the game during play. In this case, you have to add in the producer's section the information that "models by CGAXIS.com". You can sell/resell rendered moving or still images, resold as a part of a feature film, movie advertisement etc. You have a possibility to publish renders in a book, on a poster, t-shirt, magazine, cover or any other item. You have the right to use your renders in every way - charge a fee for them, modify them, to make postproduction etc.